

 PNEUMATIK-
ZERSTÄUBERDÜSEN

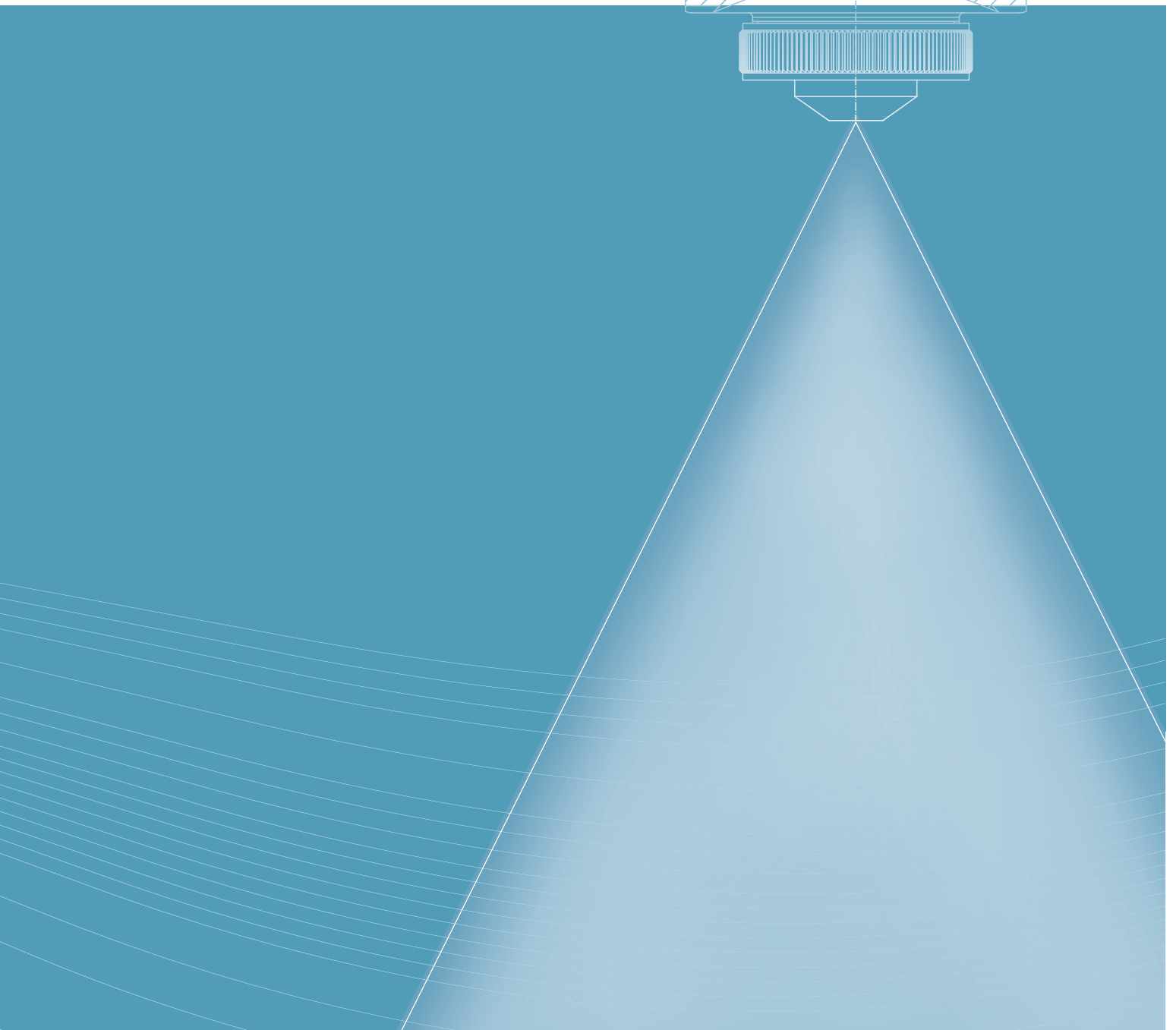

➤ PNEUMATIK-ZERSTÄUBERDÜSEN ALLGEMEINE INFORMATIONEN

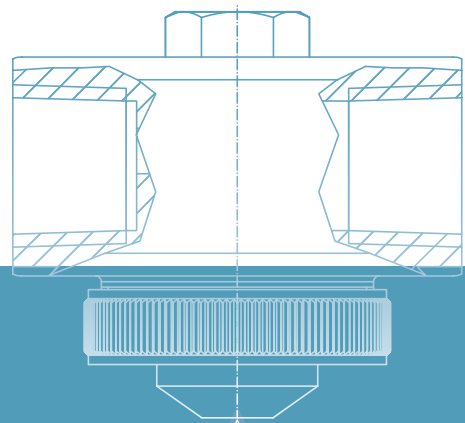

Pneumatik-Zerstäuberdüsen erzeugen sehr feine Tropfen mit kleinem Tropfenspektrum. Sie lassen sich in zwei Ausführungen aufteilen: intern mischende (für Wasser und niedrigviskose Medien) und extern mischende (für viskose Medien). Gas und Flüssigkeit werden entweder innerhalb oder außerhalb der Düse zusammengeführt. Je nach Düsenkonstruktion wird die Flüssigkeit selbstständig angesaugt oder unter Druck zugeführt. Über die Gestaltung des Düsenmundstücks lassen sich unterschiedliche Strahlformen realisieren.

Pneumatik-Zerstäuberdüsen



- Erzeugung sehr feiner Tropfen
- Unterschiedliche Varianten im Hinblick auf die Flüssigkeitszuführung
- Innere oder äußere Mischung der Medien
- Geeignet für Befeuchtung, Kühlung und Zerstäubung viskoser Medien

Flüssigkeitsdruckprinzip

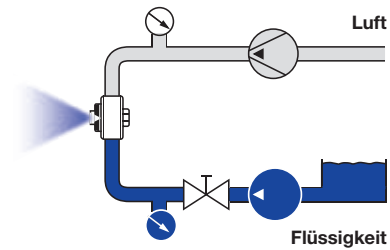

Ansaugprinzip

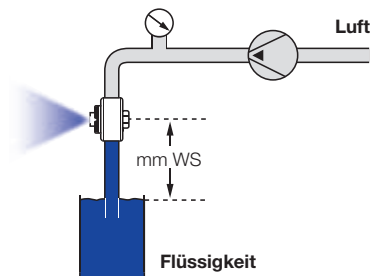



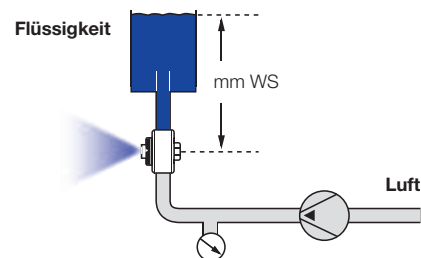

Zulaufprinzip









PNEUMATIK-ZERSTÄUBERDÜSEN BAUREIHEN-ÜBERSICHT









		Pneumatik-Zerstäuberdüsen				
						
Baureihe		140	176 ViscoMist	170	150	77X, 78X, 79X
Informationen auf Seite		53	54	auf Anfrage	auf Anfrage	auf Anfrage
Strahlform	Vollkegelstrahl	•	•	•	•	•
	Flachstrahl		•			
	Vollstrahl		•			
Art der Flüssigkeitszufuhr	Druckprinzip		•	•	•	•
	Ansaug- bzw. Zulaufprinzip	•				
Mischung der Medien	Innenmischung	•		•		
	Außenmischung		•		•	•
Volumenstrom	I/h	4,50–12,00	7,80–307,00	8,50–290,00 [l/min]	0,15–63,00 [l/min]	3,00–1.164,00
Strahlwinkel	klein (15°–30°)	•	•	•	•	•
	mittel (45°)					
	groß (60°–80°)					





					
Baureihe		136.1	136.2	136.3	136.4
Informationen auf Seite		30	32	33	36
Strahlform	Vollkegelstrahl	•	•	•	
	Flachstrahl				•
	Vollstrahl				
Art der Flüssigkeitszufuhr	Druckprinzip	•	•		•
	Ansaug- bzw. Zulaufprinzip			•	
Mischung der Medien	Innenmischung	•	•		•
	Außenmischung			•	
 Volumenstrom	l/h	0,40–93,20	0,40–132,90	0,30–66,72	0,10–76,10
 Strahlwinkel	klein (15°–30°)	•		•	
	mittel (45°)				•
	groß (60°–80°)		•		•

Pneumatik-Zerstäuberdüsen

					
136.5	136.6	166.1	166.2	166.4	166.6
38	40	44	46	47	49
		•	•		
•	•			•	•
	•	•	•	•	•
•					
•		•	•	•	
	•				•
0,80-3,20	1,68-102,10	0,40-93,20	0,40-132,90	0,10-76,10	1,68-102,10
		•			
	•			•	•
•	•		•	•	•

➤ Pneumatik-Zerstäuberdüsen, Vollkegel, Druckprinzip, Innenmischung

Baureihe 136.1



Eigenschaften:

- Feine Vollkegelzerstäubung
- Flüssigkeitsdruckprinzip
- Innenmischung

Anwendung:

- Luftbefeuchtung
- Kühlung

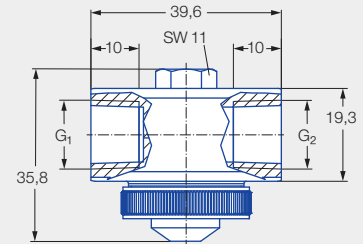

Baureihe 136.1

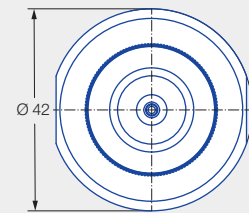
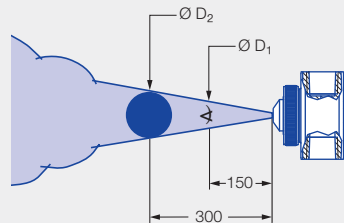

Anschluss Flüssigkeit G ₁	Anschluss Luft G ₂	Gewinde Verschluss-schraube SW 11	Gewicht [g] (Edelstahl 1.4305)
G 1/4 ISO 228	G 1/4 ISO 228	5/16-24 UNF-2A	220

Strahlwinkel	Bestell-Nr.		Engster Querschnitt Ø [mm]	Flüssigkeitsdruck p [bar]												Strahlabmessungen								
	Type	Mat.-Nr.		0,7				1,5				3,0				4,0				p Luft [bar]	p Wasser [bar]	Ø D ₁ [mm]	Ø D ₂ [mm]	
		1Y		16	p Luft [bar]	ṽ Wasser [l/h]	ṽ _n Luft [m³/h]	p Luft [bar]	ṽ Wasser [l/h]	ṽ _n Luft [m³/h]	p Luft [bar]	ṽ Wasser [l/h]	ṽ _n Luft [m³/h]	p Luft [bar]	ṽ Wasser [l/h]	ṽ _n Luft [m³/h]								
20°	136.115.xx.A2	●	●	0,5	0,4	5,9	0,3	1,4	5,8	0,8	2,4	9,1	1,1	3,0	11,0	1,2	0,8	0,7	60	100				
					0,8	3,8	0,6	1,8	4,1	1,0	2,8	7,5	1,2	3,4	9,6	1,4	1,8	1,5	60	95				
					1,2	1,7	0,9	2,2	2,2	1,4	3,2	5,9	1,5	3,8	8,2	1,6	2,6	2,0	60	100				
					-	-	-	2,6	1,2	1,7	3,6	4,4	1,8	4,2	6,8	1,9	3,2	3,0	55	95				
					-	-	-	-	-	-	4,0	2,9	2,1	4,6	5,5	2,2	4,4	4,0	55	100				
					-	-	-	-	-	-	4,4	2,0	2,5	5,0	4,1	2,5	-	-	-	-	-			
					-	-	-	-	-	-	4,8	1,1	2,8	5,4	2,9	2,8	-	-	-	-	-			
					-	-	-	-	-	-	5,2	0,4	3,0	5,8	2,1	3,1	-	-	-	-	-			
					136.125.xx.A2	●	●	0,5	0,8	4,7	1,5	1,2	7,0	1,8	2,8	9,1	3,3	3,4	10,6	3,9	1,4	0,7	55	90
									1,2	4,4	1,9	1,6	6,6	2,2	3,2	8,7	3,7	3,8	10,3	4,3	2,2	1,5	55	95
	1,6	4,0	2,3	2,0					6,2	2,6	3,6	8,4	4,1	4,2	9,9	4,6	2,8	2,0	55	100				
	2,0	3,5	2,6	2,4					5,8	3,0	4,0	8,0	4,5	4,6	9,6	5,0	3,4	3,0	60	100				
	2,4	3,0	3,0	2,8					5,4	3,4	4,4	7,7	4,8	5,0	9,3	5,4	4,2	4,0	60	100				
	2,8	2,7	3,2	3,2					4,9	3,7	4,8	7,3	5,2	5,4	8,9	5,8	-	-	-	-	-			
	3,2	2,0	3,7	3,6					4,4	4,1	5,2	7,0	5,6	5,8	8,6	6,1	-	-	-	-	-			
	3,6	1,6	4,1	4,0					3,9	4,5	5,6	6,6	5,9	-	-	-	-	-	-	-	-			
	4,0	1,3	4,5	4,4					3,5	4,8	6,0	6,2	6,3	-	-	-	-	-	-	-	-			
	4,4	1,0	4,9	4,8					3,1	5,2	-	-	-	-	-	-	-	-	-	-	-			
	4,8	0,6	5,2	5,2	2,7	5,6	-	-	-	-	-	-	-	-	-	-	-							
	-	-	-	5,6	2,3	5,9	-	-	-	-	-	-	-	-	-	-	-							
-	-	-	6,0	1,9	6,3	-	-	-	-	-	-	-	-	-	-	-								

Strahl- winkel	Bestell-Nr.		Engster Quer- schnitt Ø [mm]	Flüssigkeitsdruck p [bar]										Strahlabmessungen							
	Type	Mat.-Nr.		0,7			1,5			3,0			4,0			p Luft [bar]	p Wasser [bar]	Ø D ₁ [mm]	Ø D ₂ [mm]		
		1Y		16	p Luft [bar]	Ḃ Wasser [l/h]	Ḃ _n Luft [m ³ /h]	p Luft [bar]	Ḃ Wasser [l/h]	Ḃ _n Luft [m ³ /h]	p Luft [bar]	Ḃ Wasser [l/h]	Ḃ _n Luft [m ³ /h]	p Luft [bar]	Ḃ Wasser [l/h]					Ḃ _n Luft [m ³ /h]	
		Edelstahl 1.4404		Edelstahl 1.4305																	
20°	136.134.xx.A2	●	●	0,7	1,2	13,2	2,7	2,0	19,4	3,9	3,0	28,3	5,2	3,8	32,6	6,2	1,8	0,7	55	95	
					1,6	12,4	3,3	2,4	18,1	4,4	3,4	27,5	5,7	4,2	32,0	6,8	2,8	1,5	60	105	
					2,0	11,8	3,9	2,8	17,3	4,9	3,8	26,7	6,3	4,6	31,3	7,3	3,8	2,0	60	105	
					2,4	11,4	4,4	3,2	16,7	5,5	4,2	25,9	6,8	5,0	30,6	7,8	5,2	3,0	65	110	
					2,8	11,1	4,9	3,6	16,1	6,0	4,6	25,0	7,3	5,4	29,9	8,4	6,0	4,0	65	110	
					3,2	10,8	5,5	4,0	15,6	6,5	5,0	24,2	7,8	5,8	29,3	8,9	-	-	-	-	-
					3,6	10,6	6,0	4,4	15,2	7,0	5,4	23,6	8,4	-	-	-	-	-	-	-	-
					4,0	10,4	6,5	4,8	15,0	7,6	5,8	23,1	8,9	-	-	-	-	-	-	-	-
					4,4	10,1	7,0	5,2	14,6	8,1	-	-	-	-	-	-	-	-	-	-	-
					4,8	9,9	7,6	5,6	14,1	8,6	-	-	-	-	-	-	-	-	-	-	-
					5,2	9,5	8,1	6,0	13,8	9,1	-	-	-	-	-	-	-	-	-	-	-
					5,6	9,0	8,6	-	-	-	-	-	-	-	-	-	-	-	-	-	-
					6,0	8,5	9,2	-	-	-	-	-	-	-	-	-	-	-	-	-	-
						136.142.xx.A2	●	●	2,5	1,4	24,2	5,1	1,6	53,4	4,7	3,2	70,8	8,0	3,8	93,2	9,2
1,8	20,4	6,3	2,0	42,6						5,9	3,6	62,5	9,2	4,2	83,1	10,1	1,6	1,5	65	105	
2,2	20,0	7,2	2,4	35,3						7,2	4,0	55,7	10,6	4,6	75,3	11,3	3,0	2,0	60	105	
2,6	19,3	8,2	2,8	30,4						8,4	4,4	49,3	11,7	5,0	69,0	12,5	4,0	3,0	65	110	
3,0	17,6	9,3	3,2	28,6						9,5	4,8	44,6	12,9	5,4	63,4	13,7	6,0	4,0	65	110	
3,4	16,5	10,4	3,6	28,2						10,5	5,2	41,9	14,1	5,8	57,5	14,9	-	-	-	-	
3,8	17,0	11,4	4,0	27,3						11,5	5,6	40,4	15,1	-	-	-	-	-	-	-	
4,2	16,3	12,4	4,4	25,9						12,5	6,0	39,7	16,1	-	-	-	-	-	-	-	
4,6	15,1	13,3	4,8	24,3						13,5	-	-	-	-	-	-	-	-	-	-	
5,0	14,0	14,3	5,2	22,3						14,6	-	-	-	-	-	-	-	-	-	-	
5,4	13,1	15,3	5,6	21,8						15,7	-	-	-	-	-	-	-	-	-	-	
5,8	12,4	16,2	6,0	21,4						16,7	-	-	-	-	-	-	-	-	-	-	

Bestell- Type + Material-Nr. = Bestell-Nr.
beispiel: 136.134.xx.A2 + 1Y = 136.134.1Y.A2



➤ Pneumatik-Zerstäuberdüsen, Vollkegel, Druckprinzip, Innenmischung

Baureihe 136.2



Eigenschaften:

- Feine Vollkegelzerstäubung
- Flüssigkeitsdruckprinzip
- Innenmischung
- Besonders großer Strahlwinkel von 60°

Anwendung:

- Luftbefeuchtung
- Kühlung

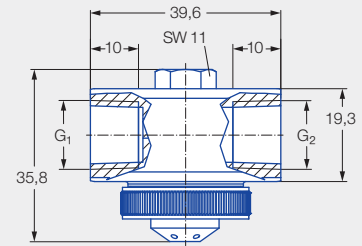

Baureihe 136.2

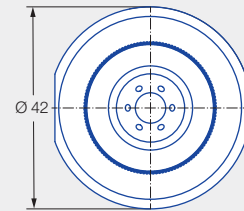
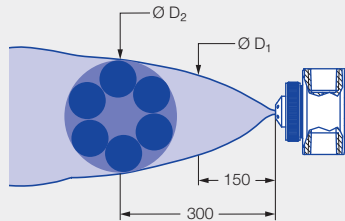

Anschluss Flüssigkeit G ₁	Anschluss Luft G ₂	Gewinde Verschluss-schraube SW 11	Gewicht [g] (Edelstahl 1.4305)
G 1/4 ISO 228	G 1/4 ISO 228	5/16-24 UNF-2A	220

Strahl-winkel	Bestell-Nr.		Engster Querschnitt Ø [mm]	Flüssigkeitsdruck p [bar]												Strahlabmessungen					
	Type	Mat.-Nr.		0,7			1,5			3,0			4,0			p Luft [bar]	p Wasser [bar]	Ø D ₁ [mm]	Ø D ₂ [mm]		
		1Y		16	p Luft [bar]	\dot{V} Wasser [l/h]	\dot{V}_n Luft [m ³ /h]	p Luft [bar]	\dot{V} Wasser [l/h]	\dot{V}_n Luft [m ³ /h]	p Luft [bar]	\dot{V} Wasser [l/h]	\dot{V}_n Luft [m ³ /h]	p Luft [bar]	\dot{V} Wasser [l/h]					\dot{V}_n Luft [m ³ /h]	
60°	136.215.xx.A2	●	●	0,5	1,0	3,0	1,3	1,6	5,8	1,7	2,8	8,5	2,4	3,8	9,4	3,1	1,0	0,7	200	330	
					1,2	1,8	1,5	1,8	4,9	1,9	3,2	7,2	2,8	4,2	8,2	3,5	1,6	1,5	230	380	
					1,4	0,7	1,8	2,0	3,8	2,1	3,6	5,7	3,2	4,6	6,9	3,9	2,4	2,0	230	385	
					-	-	-	2,2	2,8	2,3	4,0	4,0	3,6	5,0	5,4	4,2	3,2	3,0	245	390	
					-	-	-	2,4	1,7	2,5	4,4	2,2	4,1	5,4	3,8	4,7	4,2	4,0	250	410	
					-	-	-	2,6	0,8	2,8	4,8	0,8	4,5	5,8	2,3	5,2	-	-	-	-	-
					-	-	-	-	-	-	5,0	0,4	4,6	6,0	1,4	5,6	-	-	-	-	-
					-	-	-	-	-	-	-	-	-	-	-	-	-	-	-	-	-
	136.222.xx.A2	●	●	1,0	0,8	17,5	2,8	1,6	25,9	4,0	3,0	40,4	5,8	3,8	54,9	6,4	0,8	0,7	250	450	
					1,0	6,0	4,3	1,8	14,7	5,3	3,2	31,5	6,9	4,0	45,6	7,3	1,6	1,5	245	465	
					-	-	-	2,0	6,7	6,7	3,4	22,2	8,2	4,2	37,6	8,5	2,3	2,0	245	465	
					-	-	-	2,2	1,9	8,1	3,6	14,6	9,5	4,4	29,6	9,7	3,2	3,0	250	465	
					-	-	-	-	-	-	3,8	8,5	11,0	4,6	21,6	11,2	4,2	4,0	245	465	
					-	-	-	-	-	-	4,0	4,5	12,3	4,8	15,3	12,4	-	-	-	-	
					-	-	-	-	-	-	-	-	-	5,0	9,7	13,8	-	-	-	-	
					-	-	-	-	-	-	-	-	-	5,2	6,0	15,2	-	-	-	-	
	136.231.xx.A2	●	●	1,4	1,6	25,6	5,1	2,6	44,2	7,0	3,6	93,7	7,9	4,2	132,9	7,3	2,0	0,7	235	380	
					2,0	17,8	6,2	3,0	33,0	8,2	4,0	78,3	9,3	4,6	117,2	9,0	2,6	1,5	245	415	
					2,4	11,3	7,2	3,4	24,7	9,2	4,4	65,8	10,6	5,0	101,1	10,4	2,4	2,0	255	420	
					2,8	6,9	8,1	3,8	18,1	10,2	4,8	54,9	11,9	5,4	87,9	11,8	3,6	3,0	255	425	
					-	-	-	4,2	13,2	11,2	5,2	45,6	13,0	5,8	76,6	13,2	4,2	4,0	265	430	
					-	-	-	4,6	9,3	12,0	5,6	38,0	14,1	6,0	71,2	13,8	-	-	-	-	
					-	-	-	-	-	-	6,0	36,1	14,4	-	-	-	-	-	-	-	
					-	-	-	-	-	-	-	-	-	-	-	-	-	-	-	-	

Bestell- Type + Material-Nr. = Bestell-Nr.
 beispiel: 136.215.xx.A2 + 1Y = 136.215.1Y.A2



➤ Pneumatik-Zerstäuberdüsen, Vollkegel, Ansaugprinzip, Außenmischung

Baureihe 136.3



Eigenschaften:

- Besonders feine Vollkegelzerstäubung
- Ansaugprinzip
- Außenmischung

Anwendung:

- Kühlung
- Zerstäubung viskoser Medien
- Chemische Verfahrenstechnik

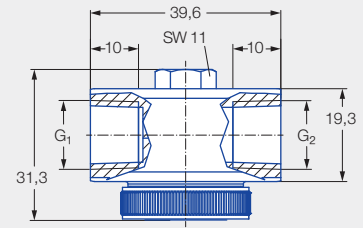

Baureihe 136.3

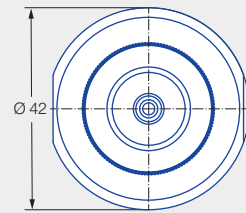
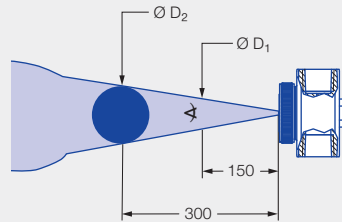

Anschluss Flüssigkeit G ₁	Anschluss Luft G ₂	Gewinde Verschluss-schraube SW 11	Gewicht [g] (Edelstahl 1.4305)
G 1/4 ISO 228	G 1/4 ISO 228	5/16-24 UNF-2A	220

Strahl-winkel	Bestell-Nr.		Engster Querschnitt Ø [mm]	Luft		V̇ Wasser [l/h]					Strahlabmessungen								
	Mat.-Nr.			p [bar]	V̇ _n [m³/h]	Wassersäule [mm WS]			Saughöhe [mm WS]		p Luft [bar]	Saughöhe [mm WS]	Ø D ₁ [mm]	Ø D ₂ [mm]					
	1Y	16				150	300	450	100	200					300	600	900		
20°	136.316.xx.A2	●	●	0,40	0,60	0,70	-	1,38	1,32	-	-	-	-	-	1,40	300	60	110	
					0,80	0,90	1,29	1,44	1,38	-	-	-	-	-	3,20	300	60	120	
					1,20	1,10	1,47	1,62	1,53	1,02	0,84	-	-	-	4,80	300	80	135	
					1,40	1,20	1,50	1,68	1,62	1,14	0,96	0,66	-	-	6,00	300	70	120	
					1,80	1,40	1,62	1,80	1,71	1,26	1,11	0,90	-	-	-	-	-	-	-
					2,00	1,60	1,68	1,86	1,77	1,32	1,17	0,96	-	-	-	-	-	-	-
					2,40	1,80	1,74	1,92	1,86	1,44	1,32	1,14	0,51	-	-	-	-	-	-
					2,60	1,90	1,80	1,98	1,89	1,50	1,32	1,20	0,63	-	-	-	-	-	-
					3,00	2,10	1,92	2,07	1,95	1,59	1,44	1,29	0,84	0,39	-	-	-	-	-
					3,20	2,20	1,95	2,10	1,98	1,65	1,50	1,35	0,96	0,48	-	-	-	-	-
					3,60	2,40	2,07	2,19	2,10	1,80	1,65	1,50	1,14	0,72	-	-	-	-	-
					3,80	2,60	2,13	2,25	2,16	1,83	1,71	1,59	1,23	0,81	-	-	-	-	-
					4,20	2,80	2,22	2,37	2,28	1,95	1,80	1,68	1,38	1,08	-	-	-	-	-
					4,40	2,90	2,25	2,40	2,34	1,98	1,89	1,77	1,44	1,14	-	-	-	-	-
					4,80	3,10	2,25	2,34	2,28	1,92	1,86	1,77	1,50	1,14	-	-	-	-	-
5,00	3,20	2,25	2,31	2,22	1,89	1,83	1,71	1,41	0,84	-	-	-	-	-					
5,40	3,40	2,13	2,25	2,16	1,80	1,68	1,56	1,05	0,30	-	-	-	-	-					
5,60	3,60	2,07	2,19	2,10	1,74	1,65	1,44	0,72	-	-	-	-	-	-					
6,00	3,80	1,98	2,10	1,95	1,56	1,50	1,26	-	-	-	-	-	-	-					





Strahl- winkel	Bestell-Nr.		Engster Quer- schnitt Ø [mm]	Luft		V̇ Wasser [l/h]						Strahlabmessungen								
	Mat.-Nr.					Wassersäule [mm WS]			Saughöhe [mm WS]											
	Type	1Y		16	p [bar]	V̇ _n [m³/h]	150	300	450	100	200	300	600	900	p Luft [bar]	Saughöhe [mm WS]	Ø D ₁ [mm]	Ø D ₂ [mm]		
		Edelstahl 1.4404		Edelstahl 1.4305																
20°	136.324.xx.A2	●	●	0,70	0,80	0,90	-	-	-	2,49	1,71	-	-	-	1,20	300	60	115		
					1,20	1,10	-	-	-	3,12	2,53	1,86	-	-	-	3,20	300	65	125	
					1,40	1,20	-	-	-	3,36	2,78	2,22	-	-	-	4,80	300	70	135	
					1,80	1,50	-	-	-	3,75	3,22	2,67	-	-	-	6,00	300	80	135	
					2,00	1,60	-	-	-	3,96	3,39	2,85	0,66	-	-	-	-	-	-	-
					2,40	1,80	-	-	-	4,29	3,73	3,21	1,41	-	-	-	-	-	-	-
					2,60	1,90	-	-	-	4,41	3,91	3,39	1,68	-	-	-	-	-	-	-
					3,00	2,10	5,43	-	-	4,71	4,18	3,75	2,07	-	-	-	-	-	-	-
					3,20	2,20	5,55	-	-	4,80	4,31	3,90	2,25	-	-	-	-	-	-	-
					3,60	2,40	5,82	-	-	5,07	4,56	4,20	2,61	-	-	-	-	-	-	-
	3,80	2,60	6,03	-	-	5,22	4,72	4,38	2,88	2,10	-	-	-	-	-	-				
	4,20	2,80	6,30	6,66	-	5,64	5,15	4,71	3,21	2,85	-	-	-	-	-	-				
	4,40	2,90	6,36	6,72	7,05	5,88	5,38	4,92	3,60	2,97	-	-	-	-	-	-				
	4,80	3,10	6,27	6,57	6,84	5,97	5,47	5,22	3,93	1,93	-	-	-	-	-	-				
	5,00	3,20	6,12	6,42	6,75	5,88	5,36	5,10	4,05	-	-	-	-	-	-	-				
	5,40	3,40	5,82	6,12	6,48	5,49	5,03	4,71	3,81	-	-	-	-	-	-	-				
	5,60	3,50	5,67	5,97	6,30	5,22	4,84	4,53	3,63	-	-	-	-	-	-	-				
	6,00	3,80	5,31	5,58	6,00	4,80	4,48	4,08	1,92	-	-	-	-	-	-	-				
	136.334.xx.A2	●	●	0,70	0,60	1,20	-	-	-	2,19	-	-	-	-	0,80	300	65	120		
					0,80	1,40	-	-	-	2,64	2,28	1,44	-	-	-	3,20	300	65	115	
1,20					1,80	-	-	-	3,39	3,00	2,73	0,78	-	-	4,80	300	70	115		
1,40					2,00	-	-	-	3,69	3,33	3,06	1,11	-	-	6,00	300	75	120		
1,80					2,30	5,19	-	-	4,20	3,87	3,51	2,16	-	-	-	-	-	-	-	
2,00					2,50	5,43	5,97	6,42	4,47	4,08	3,78	2,58	0,84	-	-	-	-	-	-	
2,40					2,80	5,79	6,27	6,72	4,86	4,53	4,20	3,30	1,44	-	-	-	-	-	-	
2,60					3,00	6,00	6,48	6,90	4,98	4,68	4,41	3,57	1,77	-	-	-	-	-	-	
3,00					3,40	6,30	6,75	7,14	5,37	5,07	4,71	3,87	2,31	-	-	-	-	-	-	
3,20					3,50	6,42	6,90	7,29	5,52	5,19	4,89	4,02	2,52	-	-	-	-	-	-	
3,60					3,90	6,75	7,17	7,59	5,82	5,55	5,19	4,29	3,42	-	-	-	-	-	-	
3,80					4,00	6,87	7,32	7,80	6,03	5,73	5,37	4,47	3,81	-	-	-	-	-	-	
4,20					4,40	7,29	7,80	8,34	6,39	6,09	5,79	4,83	4,17	-	-	-	-	-	-	
4,40					4,60	7,62	8,16	8,73	6,69	6,39	6,09	5,13	4,38	-	-	-	-	-	-	
4,80					4,90	8,37	8,85	9,21	7,32	6,99	6,69	5,76	4,86	-	-	-	-	-	-	
5,00					5,10	8,52	8,85	9,15	7,71	7,32	7,05	6,06	5,19	-	-	-	-	-	-	
5,40					5,40	8,34	8,64	8,88	7,71	7,53	7,29	6,48	5,67	-	-	-	-	-	-	
5,60					5,60	8,19	8,49	8,76	7,59	7,41	7,20	6,45	5,73	-	-	-	-	-	-	
6,00	5,90	7,86	8,16	8,43	7,26	7,05	6,84	6,15	5,64	-	-	-	-	-	-					

Strahl- winkel	Bestell-Nr.		Engster Quer- schnitt Ø [mm]	Luft		V̇ Wasser [l/h]							Strahlabmessungen					
	Type	Mat.-Nr.				Wassersäule [mm WS]			Saughöhe [mm WS]									
		1Y		16	150	300	450	100	200	300	600	900	p Luft [bar]	Saughöhe [mm WS]	Ø D ₁ [mm]	Ø D ₂ [mm]		
		Edelstahl 1.4404		Edelstahl 1.4305													p [bar]	V̇ _n [m³/h]
20°	136.342.xx.A2	●	●	1,50	1,40	3,60	-	-	-	8,82	-	-	3,93	-	1,80	300	70	120
					1,80	4,20	-	-	-	9,45	8,49	7,50	5,22	3,39	3,00	300	70	120
					2,00	4,50	11,97	-	-	9,75	8,91	7,95	5,76	4,05	4,20	300	70	120
					2,40	5,20	12,18	-	-	10,26	9,51	8,73	6,75	5,19	6,00	300	70	120
					2,60	5,50	12,27	13,32	-	10,47	9,75	9,03	7,14	5,58	-	-	-	-
					3,00	6,10	12,27	13,23	14,16	10,65	10,05	9,42	7,74	6,39	-	-	-	-
					3,20	6,40	12,30	13,17	14,07	10,74	10,23	9,63	8,13	6,81	-	-	-	-
					3,60	7,00	12,42	13,20	14,07	11,01	10,53	10,05	8,85	7,86	-	-	-	-
					3,80	7,30	12,54	13,26	14,10	11,28	10,86	10,44	9,30	8,46	-	-	-	-
					4,20	8,00	13,17	13,83	14,49	12,12	11,76	11,40	10,41	9,69	-	-	-	-
	4,40	8,30	13,53	14,13	14,73	12,48	12,15	11,76	10,80	10,08	-	-	-	-				
	4,80	8,90	13,98	14,52	15,15	12,99	12,63	12,18	11,19	10,29	-	-	-	-				
	5,00	9,20	14,04	14,52	15,15	13,05	12,66	12,30	11,16	10,11	-	-	-	-				
	5,40	9,80	13,74	14,31	14,94	12,66	12,24	11,79	10,62	9,21	-	-	-	-				
	5,60	10,10	13,35	14,04	14,64	12,27	11,82	11,37	10,08	8,52	-	-	-	-				
	6,00	10,80	12,21	12,90	-	10,98	10,50	10,17	8,70	7,05	-	-	-	-				
	136.351.xx.A2	●	●	2,50	3,20	11,50	-	-	-	-	38,92	-	-	-	3,80	300	95	135
					3,60	12,50	-	-	-	45,73	41,94	-	33,17	-	4,60	300	95	145
					3,80	13,10	-	-	-	47,81	45,14	42,29	35,36	-	5,40	300	100	150
					4,20	14,20	-	-	-	51,61	49,07	46,46	39,58	29,94	6,00	300	95	150
4,40					14,80	-	-	-	53,10	50,87	48,30	41,59	31,59	-	-	-	-	
4,80					15,90	-	63,39	-	55,30	53,40	51,26	45,06	34,68	-	-	-	-	
5,00					16,50	-	63,75	66,69	56,05	54,15	52,18	46,29	35,88	-	-	-	-	
5,40					17,60	61,12	64,17	66,72	56,71	55,04	53,17	47,62	37,83	-	-	-	-	
5,60	18,10	60,93	63,87	66,48	56,66	55,04	53,22	47,68	38,43	-	-	-	-					
6,00	19,20	59,89	62,88	65,43	55,69	53,98	52,11	45,78	37,05	-	-	-	-					

Bestell- Type + Material-Nr. = Bestell-Nr.
beispiel: 136.342.xx.A2 + 1Y = 136.342.1Y.A2



➤ Pneumatik-Zerstäuberdüsen, Flachstrahl, Druckprinzip, Innenmischung

Baureihe 136.4



Eigenschaften:

- Feine Flachstrahlerstäubung
- Flüssigkeitsdruckprinzip
- Innenmischung

Anwendung:

- Bandbefeuchtung
- Kühlung
- Warenbefeuchtung



Baureihe 136.4

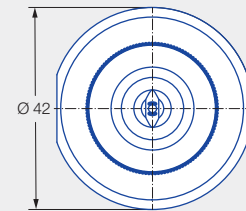
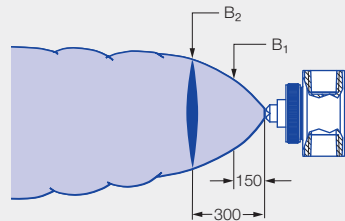
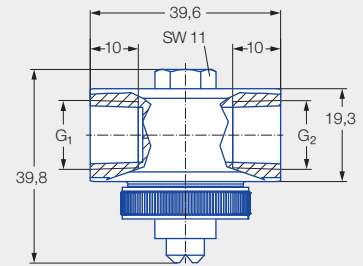

Anschluss Flüssigkeit G ₁	Anschluss Luft G ₂	Gewinde Verschluss-schraube SW 11	Gewicht [g] (Edelstahl 1.4305)
G 1/4 ISO 228	G 1/4 ISO 228	5/16-24 UNF-2A	220

Strahlwinkel	Bestell-Nr.		Engster Querschnitt Ø [mm]	Flüssigkeitsdruck p [bar]												Strahlabmessungen								
	Type	Mat.-Nr.		0,7				1,5				3,0				4,0				p Luft [bar]	p Wasser [bar]	B ₁ [mm]	B ₂ [mm]	
		1Y		16	p Luft [bar]	ṽ Wasser [l/h]	ṽ _n Luft [m³/h]	p Luft [bar]	ṽ Wasser [l/h]	ṽ _n Luft [m³/h]	p Luft [bar]	ṽ Wasser [l/h]	ṽ _n Luft [m³/h]	p Luft [bar]	ṽ Wasser [l/h]	ṽ _n Luft [m³/h]								
45°	136.414.xx.A2	●	●	0,7	1,0	7,7	1,3	1,4	14,3	1,5	2,2	22,4	2,0	3,0	25,1	2,5	1,4	0,7	85	125				
					1,2	6,0	1,5	1,6	13,0	1,6	2,6	20,0	2,3	3,4	23,0	2,8	2,4	1,5	100	145				
					1,4	4,2	1,7	1,8	11,6	1,8	3,0	17,7	2,6	3,8	20,9	3,1	3,2	2,0	105	155				
					1,6	2,7	1,9	2,0	10,2	2,0	3,4	15,5	3,0	4,2	18,9	3,5	3,8	3,0	120	170				
					1,8	1,3	2,1	2,2	8,9	2,2	3,8	13,3	3,4	4,6	16,9	3,8	4,6	4,0	130	210				
					-	-	-	2,4	7,4	2,4	4,2	11,0	3,7	5,0	14,9	4,2	-	-	-	-	-			
					-	-	-	2,6	5,9	2,6	4,6	8,8	4,1	5,4	12,8	4,6	-	-	-	-	-			
					-	-	-	2,8	4,6	2,8	5,0	6,6	4,5	5,8	10,8	5,0	-	-	-	-	-			
					-	-	-	3,0	3,2	3,0	5,4	4,3	4,9	6,0	9,8	5,2	-	-	-	-	-			
					-	-	-	3,2	2,1	3,2	5,8	2,5	5,3	-	-	-	-	-	-	-	-			
					-	-	-	3,4	1,1	3,4	6,0	1,6	5,5	-	-	-	-	-	-	-	-			
					136.443.xx.A2	●	●	1,0	1,2	13,9	1,5	1,6	26,6	1,6	3,0	37,1	2,6	3,6	45,6	2,9	1,2	0,7	110	165
	1,4	11,9	1,7	1,8					24,3	1,8	3,4	33,1	3,0	4,0	41,9	3,3	2,0	1,5	115	190				
	1,6	9,5	1,9	2,0					22,0	2,0	3,8	29,5	3,4	4,4	38,3	3,7	2,8	2,0	145	190				
	1,8	7,8	2,1	2,2					19,9	2,2	4,2	26,2	3,8	4,8	35,0	4,0	3,8	3,0	150	210				
	-	-	-	2,4					18,0	2,4	4,6	23,0	4,2	5,2	31,8	4,5	4,8	4,0	160	230				
	-	-	-	2,6					16,2	2,6	5,0	20,2	4,6	5,6	29,0	4,9	-	-	-	-	-			
	-	-	-	2,8					14,4	2,8	5,4	17,6	4,9	6,0	26,2	5,2	-	-	-	-	-			
	-	-	-	3,0					12,8	3,0	5,8	14,9	5,3	-	-	-	-	-	-	-	-			
	-	-	-	3,2					11,3	3,2	6,0	14,1	5,5	-	-	-	-	-	-	-	-			
	-	-	-	3,4					9,9	3,4	-	-	-	-	-	-	-	-	-	-	-			
	-	-	-	3,6					8,8	3,6	-	-	-	-	-	-	-	-	-	-	-			

Strahl- winkel	Bestell-Nr.		Engster Quer- schnitt Ø [mm]	Flüssigkeitsdruck p [bar]											Strahlabmessungen					
	Type	Mat.-Nr.		0,7			1,5			3,0			4,0		p Luft [bar]	p Wasser [bar]	B ₁ [mm]	B ₂ [mm]		
		1Y		16	p Luft [bar]	\dot{V} Wasser [l/h]	\dot{V}_n Luft [m ³ /h]	p Luft [bar]	\dot{V} Wasser [l/h]	\dot{V}_n Luft [m ³ /h]	p Luft [bar]	\dot{V} Wasser [l/h]	\dot{V}_n Luft [m ³ /h]	p Luft [bar]					\dot{V} Wasser [l/h]	\dot{V}_n Luft [m ³ /h]
		Edelstahl 1.4404	Edelstahl 1.4305																	
45°	136.462.xx.A2	●	●	1,5	1,2	19,0	2,6	2,0	22,0	2,0	3,0	61,8	4,0	3,8	76,1	4,6	1,2	0,7	120	140
					1,6	12,2	3,4	2,4	18,0	2,4	3,4	51,9	4,8	4,0	70,4	5,1	2,4	1,5	120	170
					2,0	9,4	4,1	2,8	14,4	2,8	3,8	44,6	5,8	4,2	65,6	5,5	3,2	2,0	120	175
					2,4	7,1	4,8	3,2	11,3	3,2	4,2	39,0	6,6	4,4	61,3	5,9	3,8	3,0	140	205
					2,8	5,7	5,4	3,6	8,8	3,6	4,6	33,4	7,4	4,6	57,3	6,4	6,0	4,0	145	205
					3,2	5,0	6,0	4,0	8,1	3,9	5,0	29,4	8,1	4,8	54,1	6,7	-	-	-	-
					3,6	3,6	6,6	4,4	6,2	4,3	5,4	25,5	8,9	5,0	51,3	7,2	-	-	-	-
					4,0	3,2	7,2	4,8	4,6	4,6	5,8	22,0	9,6	5,2	49,3	7,7	-	-	-	-
					4,4	2,2	7,8	5,2	3,2	4,9	6,0	20,6	9,9	5,4	46,5	8,2	-	-	-	-
					-	-	-	5,6	1,6	5,3	-	-	-	5,6	43,7	8,6	-	-	-	-
					-	-	-	5,8	0,8	5,4	-	-	-	5,8	41,3	8,9	-	-	-	-
					-	-	-	-	-	-	-	-	-	6,0	39,0	9,3	-	-	-	-
60°	136.425.xx.A2	●	●	0,5	0,8	6,5	1,2	1,4	9,4	1,7	2,4	13,2	2,5	2,4	16,1	2,5	1,2	0,7	155	195
					1,2	5,5	1,6	1,8	8,7	2,1	2,6	12,9	2,7	2,8	15,5	2,9	2,2	1,5	165	255
					1,6	4,7	1,9	2,2	7,9	2,4	3,0	12,3	3,0	3,2	15,0	3,2	3,0	2,0	170	265
					2,0	4,0	2,3	2,6	7,2	2,7	3,4	11,8	3,4	3,6	14,5	3,5	3,4	3,0	200	330
					2,4	3,2	2,6	3,0	6,4	3,1	3,8	11,1	3,7	4,0	13,9	3,8	5,6	4,0	200	330
					2,8	2,6	2,9	3,4	5,7	3,4	4,2	10,4	4,0	4,4	13,4	4,1	-	-	-	-
					3,0	2,2	3,1	3,8	5,1	3,7	4,6	9,8	4,3	4,8	12,8	4,5	-	-	-	-
					-	-	-	4,0	4,8	3,9	5,0	9,2	4,6	5,2	12,2	4,8	-	-	-	-
					-	-	-	4,4	4,2	4,2	5,4	8,6	5,0	5,6	11,7	5,1	-	-	-	-
					-	-	-	4,8	3,6	4,5	5,8	8,1	5,3	6,0	11,2	5,4	-	-	-	-
					-	-	-	5,2	2,8	4,8	6,0	7,8	5,4	-	-	-	-	-	-	-
					-	-	-	5,6	2,2	5,1	-	-	-	-	-	-	-	-	-	-
	-	-	-	6,0	1,6	5,5	-	-	-	-	-	-	-	-	-	-				
	136.452.xx.A2	●	●	1,5	1,0	18,8	3,9	1,8	31,0	5,3	3,2	50,1	7,7	3,8	70,7	8,2	1,0	0,7	130	185
					1,4	8,6	5,7	2,0	25,4	6,3	3,6	39,5	9,4	4,2	58,6	9,6	1,8	1,5	150	240
					1,8	7,4	7,0	2,2	20,1	7,2	4,0	31,3	11,2	4,6	48,6	11,2	2,6	2,0	155	245
					2,2	4,1	8,4	2,4	15,5	8,0	4,4	24,0	12,9	5,0	41,2	13,1	3,6	3,0	175	280
					2,6	1,0	9,8	2,6	12,4	8,9	4,8	17,7	14,5	5,4	33,6	14,8	5,0	4,0	180	285
2,8					0,1	10,3	2,8	10,4	9,6	5,2	13,4	16,0	5,8	27,5	16,4	-	-	-	-	
-	-	-	-	-	-	5,6	10,6	17,5	6,0	24,4	17,2	-	-	-	-					
-	-	-	-	-	-	6,0	8,6	18,8	-	-	-	-	-	-	-					
80°	136.433.xx.A2	●	●	0,4	1,0	11,6	2,0	1,8	18,3	2,8	3,0	31,0	3,7	3,8	37,5	4,4	1,4	0,7	150	210
					1,2	8,1	2,4	2,0	15,3	3,2	3,4	25,4	4,4	4,2	32,4	5,0	2,2	1,5	185	255
					1,4	5,3	2,8	2,2	12,2	3,6	3,8	20,6	5,1	4,6	27,7	5,7	3,0	2,0	205	300
					1,6	3,7	3,2	2,4	9,8	4,0	4,2	16,3	5,9	5,0	23,4	6,5	3,8	4,0	300	485
					-	-	-	2,6	7,6	4,3	4,6	12,5	6,6	5,4	19,4	7,2	5,2	4,0	260	395
					-	-	-	2,8	5,9	4,7	5,0	9,3	7,3	5,8	15,9	7,9	-	-	-	-
					-	-	-	3,0	4,4	5,0	5,4	6,5	8,0	6,0	14,2	8,3	-	-	-	-

Bestell- Type + Material-Nr. = Bestell-Nr.
beispiel: 136.462.xx.A2 + 1Y = 136.462.1Y.A2



➤ Pneumatik-Zerstäuberdüsen, Flachstrahl, Ansaugprinzip, Innenmischung Baureihe 136.5



Eigenschaften:

- Besonders feine Flachstrahlzerstäubung
- Ansaugprinzip
- Innenmischung

Anwendung:

- Bandbefeuchtung
- Kühlung
- Warenbefeuchtung



Baureihe 136.5

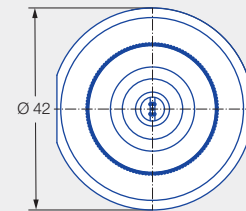
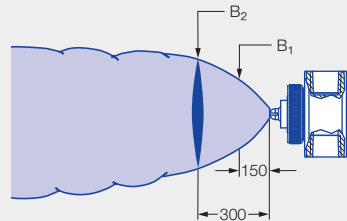
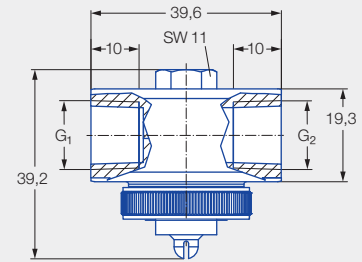

Anschluss Flüssigkeit G ₁	Anschluss Luft G ₂	Gewinde Verschluss-schraube SW 11	Gewicht [g] (Edelstahl 1.4305)
G 1/4 ISO 228	G 1/4 ISO 228	5/16-24 UNF-2A	220

Strahl-winkel	Bestell-Nr.		Engster Querschnitt Ø [mm]	Luft		V̇ Wasser [l/h]					Strahlabmessungen							
	Mat.-Nr.			p [bar]	V̇ _n [m³/h]	Wassersäule [mm WS]			Saughöhe [mm WS]		p Luft [bar]	Saughöhe [mm WS]	B ₁ [mm]	B ₂ [mm]				
	1Y	16				150	300	450	100	200					300	600	900	
	Edelstahl 1.4404	Edelstahl 1.4305																
60°	136.516.xx.A2	●	●	0,40	0,80	1,80	-	-	-	1,62	1,53	-	1,17	0,88	1,00	300	130	165
					1,20	2,20	1,89	2,13	2,19	1,80	1,77	1,68	1,41	1,16	3,00	300	150	200
					1,40	2,50	1,95	2,16	2,25	1,86	1,80	1,68	1,47	1,21	4,60	300	170	225
					1,80	2,90	1,98	2,22	2,34	1,89	1,86	1,77	1,53	1,26	6,00	300	180	240
					2,00	3,10	1,95	2,19	2,31	1,89	1,80	1,68	1,50	1,26	-	-	-	-
					2,40	3,50	1,89	2,25	2,25	1,83	1,71	1,68	1,47	1,22	-	-	-	-
					2,60	3,70	1,83	2,25	2,25	1,74	1,71	1,59	1,44	1,18	-	-	-	-
					3,00	4,20	1,74	2,01	2,22	1,71	1,62	1,56	1,44	1,28	-	-	-	-
					3,20	4,40	1,71	1,92	2,16	1,65	1,62	1,59	1,59	1,38	-	-	-	-
					3,60	4,80	1,74	1,83	2,10	1,80	1,77	1,74	1,68	1,47	-	-	-	-
					3,80	5,00	1,92	1,80	2,10	1,86	1,86	1,80	1,71	1,49	-	-	-	-
					4,20	5,50	1,98	2,04	2,19	1,92	1,83	1,83	1,68	1,70	-	-	-	-
					4,40	5,70	1,95	2,04	2,19	1,89	1,86	1,80	1,74	1,77	-	-	-	-
					4,80	6,10	2,01	2,04	2,16	2,01	2,01	2,04	2,04	1,98	-	-	-	-
					5,00	6,30	2,10	2,13	2,22	2,19	2,19	2,16	2,10	1,93	-	-	-	-
					5,40	6,80	2,31	2,34	2,28	2,25	2,22	2,16	2,04	1,86	-	-	-	-
5,60	7,00	2,31	2,28	2,25	2,19	2,16	2,10	2,01	1,80	-	-	-	-					
6,00	7,40	2,22	2,22	2,22	2,10	2,10	2,04	1,92	1,79	-	-	-	-					

Strahl- winkel	Bestell-Nr.		Engster Quer- schnitt Ø [mm]	Luft		V̇ Wasser [l/h]						Strahlabmessungen						
	Mat.-Nr.					Wassersäule [mm WS]			Saughöhe [mm WS]									
	Type	1Y		16	p [bar]	V̇ _n [m³/h]	150	300	450	100	200	300	600	900	p Luft [bar]	Saughöhe [mm WS]	B ₁ [mm]	B ₂ [mm]
Edelstahl 1.4404		Edelstahl 1.4305																
60°	136.525.xx.A2	●	●	0,50	0,60	1,60	-	-	-	2,00	-	-	-	1,00	300	155	240	
					0,80	1,90	-	-	-	2,21	2,10	1,98	-	-	3,00	300	200	295
					1,20	2,30	2,75	2,84	-	2,53	2,39	2,33	2,04	1,69	4,60	300	215	325
					1,40	2,60	2,84	2,90	3,05	2,63	2,51	2,42	2,14	1,82	6,00	300	250	400
					1,80	3,00	2,96	3,01	3,16	2,78	2,64	2,56	2,20	1,88	-	-	-	-
					2,00	3,30	2,94	3,02	3,16	2,73	2,69	2,58	2,18	1,82	-	-	-	-
					2,40	3,70	2,87	2,97	3,10	2,59	2,50	2,38	2,01	1,68	-	-	-	-
					2,60	3,90	2,82	2,86	3,04	2,49	2,46	2,29	1,91	1,62	-	-	-	-
					3,00	4,40	2,59	2,71	2,85	2,23	2,11	2,04	1,73	1,72	-	-	-	-
					3,20	4,60	2,48	2,51	2,71	2,09	1,96	1,91	1,74	1,87	-	-	-	-
					3,60	5,10	2,37	2,31	2,51	2,25	2,18	2,19	1,98	1,90	-	-	-	-
					3,80	5,30	2,34	2,37	2,52	2,22	2,23	2,15	1,99	1,85	-	-	-	-
					4,20	5,70	2,35	2,35	2,43	2,20	2,13	2,11	1,94	1,82	-	-	-	-
					4,40	6,00	2,30	2,32	2,44	2,20	2,07	2,05	1,96	1,83	-	-	-	-
					4,80	6,40	2,25	2,24	2,41	2,12	2,03	2,08	1,90	2,12	-	-	-	-
					5,00	6,60	2,20	2,21	2,37	2,09	2,03	1,98	2,25	2,27	-	-	-	-
					5,40	7,10	2,52	2,23	2,36	2,60	2,55	2,49	2,26	2,08	-	-	-	-
5,60	7,30	2,50	2,45	2,58	2,57	2,54	2,39	2,16	2,02	-	-	-	-					
6,00	7,80	2,57	2,61	2,76	2,37	2,40	2,18	1,94	1,80	-	-	-	-					

Bestell- Type + Material-Nr. = Bestell-Nr.
beispiel: 136.525.xx.A2 + 1Y = 136.525.1Y.A2



➤ Pneumatik-Zerstäuberdüsen, Flachstrahl, Druckprinzip, Außenmischung

Baureihe 136.6



Eigenschaften:

- Feine Flachstrahlzerstäubung
- Flüssigkeitsdruckprinzip
- Außenmischung

Anwendung:

- Bandbefeuchtung
- Kühlung
- Warenbefeuchtung
- Zerstäubung viskoser Medien

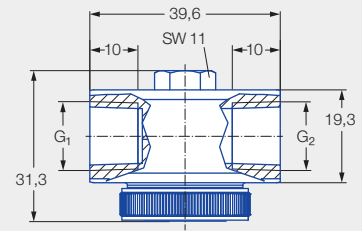

Baureihe 136.6

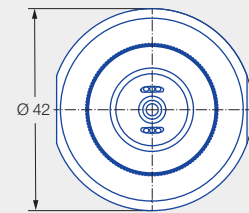
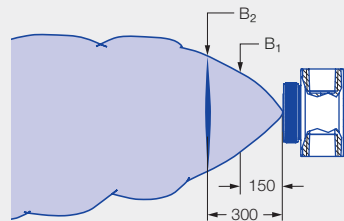

Anschluss Flüssigkeit G ₁	Anschluss Luft G ₂	Gewinde Verschluss-schraube SW 11	Gewicht [g] (Edelstahl 1.4305)
G 1/4 ISO 228	G 1/4 ISO 228	5/16-24 UNF-2A	220

Strahl-winkel	Bestell-Nr.		Engster Querschnitt Ø [mm]	Flüssigkeitsdruck p [bar]												Strahlabmessungen				
	Type	Mat.-Nr.		0,07				0,15				0,30				0,35				
		1Y		16	p Luft [bar]	ṽ Wasser [l/h]	ṽ _n Luft [m³/h]	p Luft [bar]	ṽ Wasser [l/h]	ṽ _n Luft [m³/h]	p Luft [bar]	ṽ Wasser [l/h]	ṽ _n Luft [m³/h]	p Luft [bar]	ṽ Wasser [l/h]	ṽ _n Luft [m³/h]	p Wasser [bar]	B ₁ [mm]	B ₂ [mm]	
45°	136.616.xx.A2	●	●	0,40	0,80	1,68	2,50	0,80	2,43	2,40	0,80	3,42	2,50	1,00	3,69	2,80	1,40	0,07	80	115
1,20		1,80	3,10		1,00	2,46	2,90	1,20	3,48	3,10	1,40	3,81	3,40	2,20	0,15	90	130			
1,60		1,92	3,70		1,40	2,58	3,60	1,60	3,51	3,70	1,80	3,87	4,00	3,20	0,20	90	135			
2,00		2,10	4,30		1,80	2,61	4,20	2,00	3,63	4,30	2,20	3,84	4,60	4,00	0,30	95	145			
2,40		2,07	4,90		2,20	2,76	4,80	2,40	3,63	4,90	2,60	3,90	5,20	5,00	0,35	100	145			
2,80		2,19	5,50		2,60	2,73	5,40	2,80	3,63	5,50	3,00	3,93	5,80	-	-	-	-			
3,20		2,19	6,10		3,00	2,73	6,00	3,20	3,63	6,10	3,40	3,90	6,40	-	-	-	-			
3,60		2,22	6,70		3,60	2,76	6,70	3,60	3,66	6,70	3,80	3,93	7,00	-	-	-	-			
4,00		2,22	7,30		4,00	2,76	7,30	4,00	3,69	7,30	4,20	3,96	7,60	-	-	-	-			
4,40		2,22	7,90		4,40	2,76	7,90	4,40	3,69	7,90	4,60	3,93	8,20	-	-	-	-			
4,80		2,22	8,50		4,80	2,76	8,50	4,80	3,69	8,40	5,00	3,93	8,80	-	-	-	-			
5,20		2,22	9,10		5,20	2,76	9,10	5,20	3,66	9,10	5,40	3,93	9,40	-	-	-	-			
5,60		2,22	9,60		5,60	2,76	9,70	5,60	3,66	9,60	5,80	3,87	10,00	-	-	-	-			
6,00		2,22	10,20		6,00	2,73	10,20	6,00	3,66	10,20	6,00	3,87	10,20	-	-	-	-			

Strahl- winkel	Bestell-Nr.		Engster Quer- schnitt Ø [mm]	Flüssigkeitsdruck p [bar]									Strahlabmessungen							
	Type	Mat.-Nr.		0,07			0,15			0,30			0,35			p Wasser [bar]	B ₁ [mm]	B ₂ [mm]		
		1Y		16	p Luft [bar]	ṽ Wasser [l/h]	ṽ _n Luft [m³/h]	p Luft [bar]	ṽ Wasser [l/h]	ṽ _n Luft [m³/h]	p Luft [bar]	ṽ Wasser [l/h]	ṽ _n Luft [m³/h]	p Luft [bar]	ṽ Wasser [l/h]				ṽ _n Luft [m³/h]	
		Edelstahl 1.4404		Edelstahl 1.4305																
45°	136.635.xx.A2	●	●	0,50	0,80	2,37	2,50	0,80	3,45	2,40	0,80	4,80	2,40	1,00	5,34	2,80	1,40	0,07	85	120
					1,20	2,61	3,10	1,20	3,54	3,10	1,20	5,10	3,10	1,40	5,37	3,40	2,20	0,15	95	130
					1,60	2,85	3,70	1,60	3,66	3,70	1,60	5,01	3,70	1,80	5,46	4,00	3,20	0,20	95	135
					2,00	3,03	4,30	2,00	3,72	4,30	2,10	5,10	4,30	2,20	5,46	4,60	4,00	0,30	100	140
					2,40	3,12	4,90	2,40	3,90	4,90	2,40	5,13	4,90	2,60	5,58	5,20	5,00	0,35	100	145
					2,80	3,15	5,50	2,80	3,87	5,50	2,80	5,16	5,50	3,00	5,58	5,80	-	-	-	-
					3,20	3,21	6,10	3,20	3,96	6,10	3,20	5,22	6,10	3,40	5,58	6,40	-	-	-	-
					3,60	3,18	6,70	3,60	3,96	6,70	3,60	5,25	6,70	3,80	5,58	7,00	-	-	-	-
					4,00	3,21	7,30	4,00	3,96	7,20	4,00	5,22	7,30	4,20	5,58	7,60	-	-	-	-
					4,40	3,21	7,90	4,40	3,96	7,90	4,40	5,22	7,90	4,60	5,58	8,10	-	-	-	-
					4,80	3,21	8,40	4,80	3,96	8,40	4,80	5,22	8,40	5,00	5,58	8,70	-	-	-	-
					5,20	3,21	9,00	5,20	3,96	9,00	5,20	5,22	9,00	5,40	5,58	9,30	-	-	-	-
					5,60	3,12	9,60	5,60	3,90	9,60	5,60	5,22	9,60	5,80	5,58	9,90	-	-	-	-
					6,00	3,18	10,20	6,00	3,84	10,20	6,00	5,16	10,20	6,00	5,58	10,20	-	-	-	-
	136.654.xx.A2	●	●	0,70	0,80	5,25	2,40	0,80	7,29	2,40	1,20	10,11	3,10	1,60	11,07	3,70	1,40	0,07	95	135
					1,20	5,64	3,10	1,20	7,44	3,10	1,60	10,23	3,70	2,00	11,22	4,30	2,20	0,15	100	150
					1,60	5,79	3,70	1,60	7,62	3,70	2,00	10,38	4,30	2,40	11,28	4,90	3,20	0,20	105	160
					2,00	6,18	4,30	2,00	7,86	4,30	2,40	10,47	4,90	2,80	11,31	5,50	4,00	0,30	105	160
					2,40	6,24	4,90	2,40	7,92	4,90	2,80	10,59	5,50	3,20	11,43	6,10	5,00	0,35	105	160
					2,80	6,27	5,50	2,80	8,04	5,50	3,20	10,59	6,10	3,60	11,46	6,60	-	-	-	-
					3,20	6,39	6,10	3,20	8,13	6,10	3,60	10,62	6,70	4,00	11,43	7,20	-	-	-	-
					3,60	6,42	6,60	3,60	8,13	6,70	4,00	10,62	7,20	4,40	11,37	7,80	-	-	-	-
					4,00	6,45	7,20	4,00	8,13	7,20	4,40	10,62	7,80	4,80	11,37	8,40	-	-	-	-
					4,40	6,42	7,80	4,40	8,07	7,80	4,80	10,59	8,40	5,20	11,34	9,00	-	-	-	-
					4,80	6,30	8,40	4,80	8,04	8,40	5,20	10,56	9,00	5,60	11,22	9,60	-	-	-	-
					5,20	6,24	9,00	5,20	7,86	9,00	5,60	10,50	9,60	6,00	11,16	10,10	-	-	-	-
					5,60	6,09	9,60	5,60	7,83	9,60	6,00	10,35	10,20	-	-	-	-	-	-	-
					6,00	5,85	10,20	6,00	7,59	10,20	-	-	-	-	-	-	-	-	-	-
60°	136.626.xx.A2	●	●	0,40	0,80	1,83	2,80	0,80	2,49	2,80	0,80	3,48	2,80	0,80	3,78	2,80	1,60	0,07	85	135
					1,20	1,98	3,60	1,20	2,58	3,50	1,20	3,60	3,50	1,20	3,87	3,60	2,40	0,15	90	140
					1,60	2,10	4,30	1,60	2,70	4,20	1,60	3,66	4,30	1,60	3,90	4,20	3,20	0,20	90	140
					2,00	2,16	4,90	2,00	2,82	4,90	2,00	3,69	4,90	2,00	3,96	4,90	4,00	0,30	100	145
					2,40	2,25	5,60	2,40	2,85	5,60	2,40	3,69	5,60	2,40	3,96	5,60	5,20	0,35	105	150
					2,80	2,34	6,30	2,80	2,88	6,30	2,80	3,72	6,30	2,80	4,02	6,30	-	-	-	-
					3,20	2,31	7,00	3,20	2,88	7,00	3,20	3,78	7,00	3,20	3,99	7,00	-	-	-	-
					3,60	2,34	7,60	3,60	2,88	7,70	3,60	3,78	7,60	3,60	4,02	7,70	-	-	-	-
					4,00	2,40	8,40	4,00	2,94	8,40	4,00	3,81	8,30	4,00	4,05	8,30	-	-	-	-
					4,40	2,40	9,00	4,40	2,91	9,00	4,40	3,81	9,00	4,40	4,02	9,00	-	-	-	-
					4,80	2,40	9,70	4,80	2,97	9,70	4,80	3,81	9,70	4,80	4,08	9,70	-	-	-	-
					5,20	2,43	10,40	5,20	2,97	10,40	5,20	3,81	10,40	5,20	4,05	10,40	-	-	-	-
					5,60	2,43	11,20	5,60	2,97	11,10	5,60	3,81	11,10	5,60	4,05	11,00	-	-	-	-
					6,00	2,43	11,80	6,00	2,97	11,80	6,00	3,81	11,80	6,00	4,05	11,80	-	-	-	-





Strahlwinkel	Bestell-Nr.		Engster Querschnitt Ø [mm]	Flüssigkeitsdruck p [bar]									Strahlabmessungen							
	Type	Mat.-Nr.		0,07			0,15			0,30			0,35			p Wasser [bar]	B ₁ [mm]	B ₂ [mm]		
		1Y		16	p Luft [bar]	ṽ Wasser [l/h]	ṽ _n Luft [m³/h]	p Luft [bar]	ṽ Wasser [l/h]	ṽ _n Luft [m³/h]	p Luft [bar]	ṽ Wasser [l/h]	ṽ _n Luft [m³/h]	p Luft [bar]	ṽ Wasser [l/h]				ṽ _n Luft [m³/h]	
		Edelstahl 1.4404		Edelstahl 1.4305																
60°	136.645.xx.A2	●	●	0,50	0,80	2,73	2,80	0,80	3,69	2,80	1,00	5,16	3,20	1,00	5,55	3,10	1,60	0,07	100	140
					1,20	2,82	3,50	1,20	3,87	3,50	1,40	5,31	3,90	1,40	5,64	3,90	2,40	0,15	110	150
					1,60	3,09	4,20	1,60	3,99	4,20	1,80	5,37	4,60	1,80	5,67	4,60	3,20	0,20	115	155
					2,00	3,27	4,90	2,00	4,11	4,90	2,20	5,37	5,20	2,20	5,76	5,20	4,00	0,30	125	160
					2,40	3,36	5,60	2,40	4,17	5,60	2,60	5,43	5,90	2,60	5,82	5,90	5,20	0,35	130	165
					2,80	3,39	6,20	2,80	4,20	6,30	3,00	5,49	6,60	3,00	5,82	6,60	-	-	-	-
					3,20	3,45	7,00	3,20	4,26	7,00	3,40	5,49	7,20	3,40	5,88	7,30	-	-	-	-
					3,60	3,48	7,60	3,60	4,29	7,60	3,80	5,55	8,00	3,80	5,88	8,00	-	-	-	-
					4,00	3,51	8,30	4,00	4,32	8,30	4,20	5,55	8,60	4,20	5,88	8,70	-	-	-	-
					4,40	3,54	9,00	4,40	4,35	9,00	4,60	5,58	9,30	4,60	5,94	9,30	-	-	-	-
					4,80	3,57	9,70	4,80	4,38	9,70	5,00	5,55	10,00	5,00	5,94	10,10	-	-	-	-
					5,20	3,57	10,40	5,20	4,35	10,40	5,40	5,61	10,70	5,40	5,94	10,70	-	-	-	-
	5,60	3,60	11,00	5,60	4,35	11,10	5,80	5,61	11,40	5,80	5,94	11,40	-	-	-	-				
	6,00	3,60	11,70	6,00	4,38	11,70	6,00	5,61	11,80	6,00	5,97	11,80	-	-	-	-				
	0,80	5,46	2,80	1,00	7,68	3,20	1,00	10,50	3,20	1,00	11,28	3,20	1,60	0,07	110	140				
	1,20	5,91	3,50	1,40	7,95	3,90	1,40	10,71	3,90	1,40	11,52	3,90	2,40	0,15	130	160				
	1,60	6,15	4,20	1,80	8,13	4,60	1,80	10,83	4,60	1,80	11,58	4,50	3,20	0,20	140	170				
	2,00	6,42	4,90	2,20	8,34	5,30	2,20	11,01	5,30	2,20	11,70	5,20	4,00	0,30	150	180				
	2,40	6,63	5,60	2,60	8,46	5,90	2,60	11,07	5,90	2,60	11,79	5,90	5,20	0,35	155	200				
	2,80	6,75	6,30	3,00	8,58	6,60	3,00	11,16	6,60	3,00	11,88	6,60	-	-	-	-				
	3,20	6,93	6,90	3,40	8,67	7,30	3,40	11,19	7,30	3,40	11,94	7,30	-	-	-	-				
	3,60	6,99	7,60	3,80	8,73	8,00	3,80	11,25	8,00	3,80	12,00	8,00	-	-	-	-				
	4,00	7,05	8,30	4,20	8,76	8,70	4,20	11,28	8,60	4,20	12,03	8,70	-	-	-	-				
	4,40	7,11	9,00	4,60	8,82	9,30	4,60	11,34	9,40	4,60	12,06	9,40	-	-	-	-				
	4,80	7,11	9,70	5,00	8,82	10,10	5,00	11,37	10,00	5,00	12,06	10,10	-	-	-	-				
	5,20	7,17	10,40	5,40	8,82	10,70	5,40	11,37	10,70	5,40	12,09	10,70	-	-	-	-				
	5,60	7,11	11,10	5,80	8,85	11,40	5,80	11,40	11,40	5,80	12,12	11,40	-	-	-	-				
	6,00	7,20	11,80	6,00	8,85	11,80	6,00	11,40	11,70	6,00	12,15	11,80	-	-	-	-				
	0,60	13,89	5,60	1,00	18,51	7,60	1,60	24,81	10,20	2,00	26,61	11,80	1,60	0,07	115	160				
	1,00	14,28	7,60	1,40	18,51	9,30	2,00	24,66	11,70	2,40	26,31	13,50	2,40	0,15	120	160				
	1,40	14,28	9,40	1,80	18,33	11,00	2,40	24,42	13,30	2,80	25,65	15,10	3,20	0,20	120	160				
	1,80	14,10	11,00	2,20	17,91	12,70	2,80	23,52	15,10	3,20	24,57	16,60	4,00	0,30	120	165				
	2,20	13,68	12,60	2,60	17,37	14,20	3,20	22,47	16,60	3,60	23,28	18,30	5,20	0,35	120	170				
	2,60	13,62	14,20	3,00	16,65	15,90	3,60	21,30	18,40	4,00	21,93	19,90	-	-	-	-				
	3,00	13,29	18,90	3,40	15,93	17,30	4,00	20,10	19,80	4,40	20,34	21,50	-	-	-	-				
	3,40	12,87	17,40	3,80	15,06	19,00	4,40	18,78	21,50	4,80	19,20	23,10	-	-	-	-				
3,80	12,57	19,10	4,20	14,58	20,80	4,80	17,52	23,20	5,20	18,06	24,70	-	-	-	-					
4,20	12,18	20,80	4,60	13,83	22,30	5,20	16,71	24,80	5,60	17,01	26,30	-	-	-	-					
4,60	11,79	22,40	5,00	13,08	24,00	5,60	15,63	26,40	6,00	15,87	28,00	-	-	-	-					
5,00	10,95	24,00	5,40	12,30	25,60	5,80	15,12	27,30	-	-	-	-	-	-	-					
5,40	10,44	25,60	5,80	11,52	27,20	6,00	14,76	28,00	-	-	-	-	-	-	-					
5,80	9,57	27,20	6,00	11,04	28,10	-	-	-	-	-	-	-	-	-	-					
6,00	8,97	28,10	-	-	-	-	-	-	-	-	-	-	-	-	-					

Strahl- winkel	Bestell-Nr.		Engster Quer- schnitt Ø [mm]	Flüssigkeitsdruck p [bar]												Strahlabmessungen				
	Type	Mat.-Nr.		0,07			0,15			0,30			0,35			p Luft [bar]	p Wasser [bar]	B ₁ [mm]	B ₂ [mm]	
		1Y		16	p Luft [bar]	ṽ Wasser [l/h]	ṽ _n Luft [m³/h]	p Luft [bar]	ṽ Wasser [l/h]	ṽ _n Luft [m³/h]	p Luft [bar]	ṽ Wasser [l/h]	ṽ _n Luft [m³/h]	p Luft [bar]	ṽ Wasser [l/h]					ṽ _n Luft [m³/h]
		Edelstahl 1.4404		Edelstahl 1.4305																
60°	136.682.xx.A2	●	●	1,50	1,00	22,41	7,50	1,40	28,95	9,30	1,80	41,22	11,10	2,00	44,04	11,80	1,60	0,07	110	155
					1,40	20,19	9,30	1,80	26,07	10,90	2,20	34,92	12,60	2,40	39,09	13,40	2,40	0,15	120	155
					1,80	18,75	11,00	2,20	23,94	12,50	2,60	33,18	14,20	2,80	35,16	15,10	3,20	0,20	120	160
					2,20	17,88	12,50	2,60	22,23	14,30	3,00	30,45	15,90	3,20	32,22	16,70	4,00	0,30	120	165
					2,60	17,10	14,20	3,00	21,12	15,90	3,40	28,29	17,50	3,60	30,18	18,30	5,20	0,35	120	175
					3,00	16,47	15,90	3,40	20,10	17,50	3,80	26,64	19,10	4,00	28,32	19,90	-	-	-	-
					3,40	16,08	17,50	3,80	19,44	19,10	4,20	25,35	20,70	4,40	26,94	21,50	-	-	-	-
					3,80	15,90	19,10	4,20	18,99	20,70	4,60	24,24	22,30	4,80	25,59	23,10	-	-	-	-
					4,20	15,90	20,70	4,60	18,45	22,30	5,00	23,13	24,00	5,20	24,36	24,80	-	-	-	-
					4,60	15,81	22,30	5,00	18,18	24,00	5,40	22,14	25,50	5,60	23,28	26,40	-	-	-	-
					5,00	15,21	23,90	5,40	17,25	25,40	5,80	21,12	27,20	6,00	22,17	28,00	-	-	-	-
					5,40	13,92	25,50	5,80	15,72	27,20	6,00	20,67	28,00	-	-	-	-	-	-	-
	5,80	12,09	27,20	6,00	14,91	28,00	-	-	-	-	-	-	-	-	-	-				
	6,00	11,07	28,00	-	-	-	-	-	-	-	-	-	-	-	-	-				
	136.691.xx.A2	●	●	2,50	1,40	52,00	13,80	2,00	67,30	17,50	2,60	92,30	21,20	2,60	102,10	21,20	1,60	0,07	150	200
					1,80	50,00	16,30	2,40	64,60	20,10	3,00	87,70	23,60	3,00	97,20	23,70	2,40	0,15	160	205
					2,20	48,60	18,80	2,80	62,00	22,50	3,40	84,30	26,00	3,40	92,50	26,10	3,20	0,20	160	205
					2,60	47,50	21,30	3,20	60,40	24,90	3,80	80,70	28,50	3,80	88,40	28,50	4,00	0,30	160	210
					3,00	46,50	23,70	3,60	58,00	27,30	4,20	77,00	30,90	4,20	85,20	31,00	5,20	0,35	150	210
					3,40	45,40	26,10	4,00	56,20	29,80	4,60	74,40	33,40	4,60	81,30	33,40	-	-	-	-
3,80					44,40	28,60	4,40	54,20	32,10	5,00	71,10	35,90	5,00	78,20	35,80	-	-	-	-	
4,20					42,90	31,00	4,80	52,40	34,70	5,40	68,10	38,30	5,40	74,30	38,20	-	-	-	-	
4,60					41,50	33,40	5,20	49,90	37,10	5,80	64,30	40,80	5,80	71,10	40,70	-	-	-	-	
5,00					39,90	35,80	5,60	48,10	39,50	6,00	63,20	42,00	6,00	68,90	41,90	-	-	-	-	
5,40					38,90	38,30	6,00	46,40	42,00	-	-	-	-	-	-	-	-	-	-	
5,60					38,50	39,40	-	-	-	-	-	-	-	-	-	-	-	-	-	

Bestell- Type + Material-Nr. = Bestell-Nr.
beispiel: 136.682.xx.A2 + 1Y = 136.682.1Y.A2



➤ Pneumatik-Zerstäuberdüsen, Vollkegel, Druckprinzip, Innenmischung

Baureihe 166.1



Eigenschaften:

- Version mit Magnetventil
- Feine Vollkegelzerstäubung
- Flüssigkeitsdruckprinzip
- Innenmischung

Anwendung:

- Luftbefeuchtung
- Kühlung

Technische Daten:

- Betriebsdruck: 0–6 bar
- Spannung: 24 V DC
- Leistung: 8 W
- Schaltfrequenz: ca. 500/min
- Schutzart: IP 67
- Umgebungstemperatur: +10 °C/+50 °C
- Kabellänge: 1.000 mm
- Dichtwerkstoff: EPDM



Baureihe 166.1

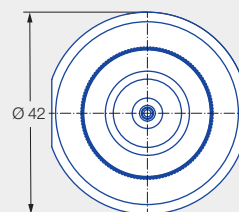
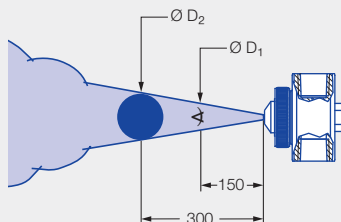
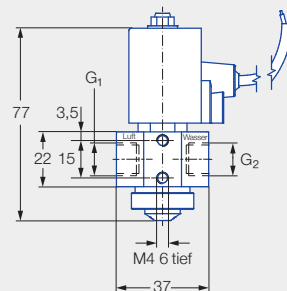

Anschluss Luft G ₁	Anschluss Wasser G ₂	Gewicht [g]
G 1/4 ISO 228	G 1/4 ISO 228	410

Strahlwinkel	Bestell-Nr.		Engster Querschnitt Ø [mm]	Flüssigkeitsdruck p [bar]												Strahlabmessungen					
	Type	Mat.-Nr.		0,7				1,5				3,0				4,0				Ø D ₁ [mm]	Ø D ₂ [mm]
		16		p Luft [bar]	V̇ Wasser [l/h]	V̇ _n Luft [m³/h]	p Luft [bar]	V̇ Wasser [l/h]	V̇ _n Luft [m³/h]	p Luft [bar]	V̇ Wasser [l/h]	V̇ _n Luft [m³/h]	p Luft [bar]	V̇ Wasser [l/h]	V̇ _n Luft [m³/h]	p Luft [bar]	p Wasser [bar]				
20°	166.115.xx.A2	●	0,5	0,4	5,9	0,3	1,4	5,8	0,8	2,4	9,1	1,1	3,0	11,0	1,2	0,8	0,7	60	100		
				0,8	3,8	0,6	1,8	4,1	1,0	2,8	7,5	1,2	3,4	9,6	1,4	1,8	1,5	60	95		
				1,2	1,7	0,9	2,2	2,2	1,4	3,2	5,9	1,5	3,8	8,2	1,6	2,6	2,0	60	100		
				-	-	-	2,6	1,2	1,7	3,6	4,4	1,8	4,2	6,8	1,9	3,2	3,0	55	95		
				-	-	-	-	-	-	4,0	2,9	2,1	4,6	5,5	2,2	4,4	4,0	55	100		
				-	-	-	-	-	-	4,4	2,0	2,5	5,0	4,1	2,5	-	-	-	-	-	
				-	-	-	-	-	-	4,8	1,1	2,8	5,4	2,9	2,8	-	-	-	-	-	
				-	-	-	-	-	-	5,2	0,4	3,0	5,8	2,1	3,1	-	-	-	-	-	
				0,8	4,7	1,5	1,2	7,0	1,8	2,8	9,1	3,3	3,4	10,6	3,9	1,4	0,7	55	90		
	1,2	4,4	1,9	1,6	6,6	2,2	3,2	8,7	3,7	3,8	10,3	4,3	2,2	1,5	55	95					
	1,6	4,0	2,3	2,0	6,2	2,6	3,6	8,4	4,1	4,2	9,9	4,6	2,8	2,0	55	100					
	2,0	3,5	2,6	2,4	5,8	3,0	4,0	8,0	4,5	4,6	9,6	5,0	3,4	3,0	60	100					
	2,4	3,0	3,0	2,8	5,4	3,4	4,4	7,7	4,8	5,0	9,3	5,4	4,2	4,0	60	100					
	2,8	2,7	3,2	3,2	4,9	3,7	4,8	7,3	5,2	5,4	8,9	5,8	-	-	-	-	-				
	3,2	2,0	3,7	3,6	4,4	4,1	5,2	7,0	5,6	5,8	8,6	6,1	-	-	-	-	-				
	3,6	1,6	4,1	4,0	3,9	4,5	5,6	6,6	5,9	-	-	-	-	-	-	-	-				
	4,0	1,3	4,5	4,4	3,5	4,8	6,0	6,2	6,3	-	-	-	-	-	-	-	-				
	4,4	1,0	4,9	4,8	3,1	5,2	-	-	-	-	-	-	-	-	-	-	-				
4,8	0,6	5,2	5,2	2,7	5,6	-	-	-	-	-	-	-	-	-	-	-					
-	-	-	5,6	2,3	5,9	-	-	-	-	-	-	-	-	-	-	-					
-	-	-	6,0	1,9	6,3	-	-	-	-	-	-	-	-	-	-	-					

Strahl- winkel	Bestell-Nr.		Engster Quer- schnitt Ø [mm]	Flüssigkeitsdruck p [bar]												Strahlabmessungen					
	Type	Mat.-Nr.		0,7			1,5			3,0			4,0								
		16		p Luft [bar]	V̇ Wasser [l/h]	V̇ _n Luft [m³/h]	p Luft [bar]	V̇ Wasser [l/h]	V̇ _n Luft [m³/h]	p Luft [bar]	V̇ Wasser [l/h]	V̇ _n Luft [m³/h]	p Luft [bar]	V̇ Wasser [l/h]	V̇ _n Luft [m³/h]	p Luft [bar]	p Wasser [bar]	Ø D ₁ [mm]	Ø D ₂ [mm]		
		Edelstahl 1.4305																			
20°	166.134.xx.A2	●	0,7	1,2	13,2	2,7	2,0	19,4	3,9	3,0	28,3	5,2	3,8	32,6	6,2	1,8	0,7	55	95		
				1,6	12,4	3,3	2,4	18,1	4,4	3,4	27,5	5,7	4,2	32,0	6,8	2,8	1,5	60	105		
				2,0	11,8	3,9	2,8	17,3	4,9	3,8	26,7	6,3	4,6	31,3	7,3	3,8	2,0	60	105		
				2,4	11,4	4,4	3,2	16,7	5,5	4,2	25,9	6,8	5,0	30,6	7,8	5,2	3,0	65	110		
				2,8	11,1	4,9	3,6	16,1	6,0	4,6	25,0	7,3	5,4	29,9	8,4	6,0	4,0	65	110		
				3,2	10,8	5,5	4,0	15,6	6,5	5,0	24,2	7,8	5,8	29,3	8,9	-	-	-	-	-	
				3,6	10,6	6,0	4,4	15,2	7,0	5,4	23,6	8,4	-	-	-	-	-	-	-	-	-
				4,0	10,4	6,5	4,8	15,0	7,6	5,8	23,1	8,9	-	-	-	-	-	-	-	-	-
				4,4	10,1	7,0	5,2	14,6	8,1	-	-	-	-	-	-	-	-	-	-	-	-
				4,8	9,9	7,6	5,6	14,1	8,6	-	-	-	-	-	-	-	-	-	-	-	-
				5,2	9,5	8,1	6,0	13,8	9,1	-	-	-	-	-	-	-	-	-	-	-	-
				5,6	9,0	8,6	-	-	-	-	-	-	-	-	-	-	-	-	-	-	-
	6,0	8,5	9,2	-	-	-	-	-	-	-	-	-	-	-	-	-	-	-			
	166.142.xx.A2	●	2,5	1,4	24,2	5,1	1,6	53,4	4,7	3,2	70,8	8,0	3,8	93,2	9,2	0,8	0,7	60	100		
				1,8	20,4	6,3	2,0	42,6	5,9	3,6	62,5	9,2	4,2	83,1	10,1	1,6	1,5	65	105		
				2,2	20,0	7,2	2,4	35,3	7,2	4,0	55,7	10,6	4,6	75,3	11,3	3,0	2,0	60	105		
				2,6	19,3	8,2	2,8	30,4	8,4	4,4	49,3	11,7	5,0	69,0	12,5	4,0	3,0	65	110		
				3,0	17,6	9,3	3,2	28,6	9,5	4,8	44,6	12,9	5,4	63,4	13,7	6,0	4,0	65	110		
				3,4	16,5	10,4	3,6	28,2	10,5	5,2	41,9	14,1	5,8	57,5	14,9	-	-	-	-	-	
				3,8	17,0	11,4	4,0	27,3	11,5	5,6	40,4	15,1	-	-	-	-	-	-	-	-	
4,2				16,3	12,4	4,4	25,9	12,5	6,0	39,7	16,1	-	-	-	-	-	-	-	-		
4,6	15,1	13,3	4,8	24,3	13,5	-	-	-	-	-	-	-	-	-	-	-	-				
5,0	14,0	14,3	5,2	22,3	14,6	-	-	-	-	-	-	-	-	-	-	-	-				
5,4	13,1	15,3	5,6	21,8	15,7	-	-	-	-	-	-	-	-	-	-	-	-				
5,8	12,4	16,2	6,0	21,4	16,7	-	-	-	-	-	-	-	-	-	-	-	-				

Bestell- Type + Material-Nr. = Bestell-Nr.
beispiel: 166.134.xx.A2 + 16 = 166.134.16.A2



➤ Pneumatik-Zerstäuberdüsen, Vollkegel, Druckprinzip, Innenmischung

Baureihe 166.2



Eigenschaften:

- Version mit Magnetventil
- Feine Vollkegelzerstäubung
- Flüssigkeitsdruckprinzip
- Innenmischung
- Besonders großer Strahlwinkel von 60°

Anwendung:

- Luftbefeuchtung
- Kühlung

Technische Daten:

- Betriebsdruck: 0–6 bar
- Spannung: 24 V DC
- Leistung: 8 W
- Schaltfrequenz: ca. 500/min
- Schutzart: IP 67
- Umgebungstemperatur: +10 °C / +50 °C
- Kabellänge: 1.000 mm
- Dichtwerkstoff: EPDM



Baureihe 166.2

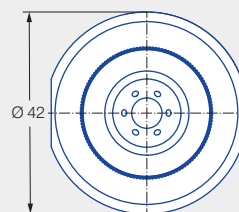
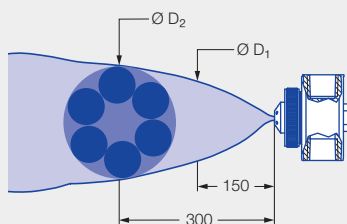
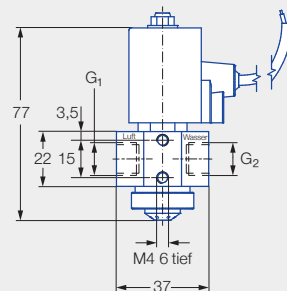

Anschluss Luft G ₁	Anschluss Wasser G ₂	Gewicht [g]
G 1/4 ISO 228	G 1/4 ISO 228	410

Strahlwinkel	Bestell-Nr.		Engster Querschnitt Ø [mm]	Flüssigkeitsdruck p [bar]												Strahlabmessungen			
	Type	Mat.-Nr.		0,7			1,5			3,0			4,0			p Luft [bar]	p Wasser [bar]	Ø D ₁ [mm]	Ø D ₂ [mm]
		16		p Luft [bar]	V̇ Wasser [l/h]	V̇ ₀ Luft [m ³ /h]	p Luft [bar]	V̇ Wasser [l/h]	V̇ ₀ Luft [m ³ /h]	p Luft [bar]	V̇ Wasser [l/h]	V̇ ₀ Luft [m ³ /h]	p Luft [bar]	V̇ Wasser [l/h]	V̇ ₀ Luft [m ³ /h]				
60°	166.215.xx.A2	●	0,5	1,0	3,0	1,3	1,6	5,8	1,7	2,8	8,5	2,4	3,8	9,4	3,1	1,0	0,7	200	330
				1,2	1,8	1,5	1,8	4,9	1,9	3,2	7,2	2,8	4,2	8,2	3,5	1,6	1,5	230	380
				1,4	0,7	1,8	2,0	3,8	2,1	3,6	5,7	3,2	4,6	6,9	3,9	2,4	2,0	230	385
				-	-	-	2,2	2,8	2,3	4,0	4,0	3,6	5,0	5,4	4,2	3,2	3,0	245	390
				-	-	-	2,4	1,7	2,5	4,4	2,2	4,1	5,4	3,8	4,7	4,2	4,0	250	410
				-	-	-	2,6	0,8	2,8	4,8	0,8	4,5	5,8	2,3	5,2	-	-	-	-
	166.222.xx.A2	●	1,0	0,8	17,5	2,8	1,6	25,9	4,0	3,0	40,4	5,8	3,8	54,9	6,4	0,8	0,7	250	450
				1,0	6,0	4,3	1,8	14,7	5,3	3,2	31,5	6,9	4,0	45,6	7,3	1,6	1,5	245	465
				-	-	-	2,0	6,7	6,7	3,4	22,2	8,2	4,2	37,6	8,5	2,3	2,0	245	465
				-	-	-	2,2	1,9	8,1	3,6	14,6	9,5	4,4	29,6	9,7	3,2	3,0	250	465
				-	-	-	-	-	-	3,8	8,5	11,0	4,6	21,6	11,2	4,2	4,0	245	465
				-	-	-	-	-	-	4,0	4,5	12,3	4,8	15,3	12,4	-	-	-	-
				-	-	-	-	-	-	-	-	-	5,0	9,7	13,8	-	-	-	-
				-	-	-	-	-	-	-	-	-	5,2	6,0	15,2	-	-	-	-
	166.231.xx.A2	●	1,4	1,6	25,6	5,1	2,6	44,2	7,0	3,6	93,7	7,9	4,2	132,9	7,3	2,0	0,7	235	380
				2,0	17,8	6,2	3,0	33,0	8,2	4,0	78,3	9,3	4,6	117,2	9,0	2,6	1,5	245	415
				2,4	11,3	7,2	3,4	24,7	9,2	4,4	65,8	10,6	5,0	101,1	10,4	2,4	2,0	255	420
				2,8	6,9	8,1	3,8	18,1	10,2	4,8	54,9	11,9	5,4	87,9	11,8	3,6	3,0	255	425
-				-	-	4,2	13,2	11,2	5,2	45,6	13,0	5,8	76,6	13,2	4,2	4,0	265	430	
-				-	-	4,6	9,3	12,0	5,6	38,0	14,1	6,0	71,2	13,8	-	-	-	-	
-				-	-	-	-	-	6,0	36,1	14,4	-	-	-	-	-	-	-	

Bestell- Type + Material-Nr. = Bestell-Nr.
 beispiel: 166.215.xx.A2 + 16 = 166.215.16.A2





Pneumatik-Zerstäuberdüsen, Flachstrahl, Druckprinzip, Innenmischung Baureihe 166.4



Eigenschaften:

- Version mit Magnetventil
- Feine Flachstrahlerzerstäubung
- Flüssigkeitsdruckprinzip
- Innenmischung

Anwendung:

- Bandbefeuchtung
- Kühlung
- Warenbefeuchtung

Technische Daten:

- Betriebsdruck: 0–6 bar
- Spannung: 24 V DC
- Leistung: 8 W
- Schaltfrequenz: ca. 500/min
- Schutzart: IP 67
- Umgebungstemperatur:
+10 °C / +50 °C
- Kabellänge: 1.000 mm
- Dichtwerkstoff: EPDM



Baureihe 166.4

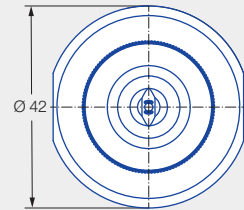
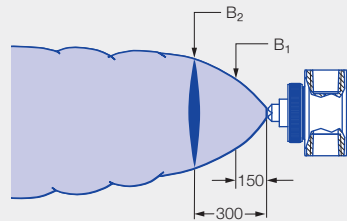
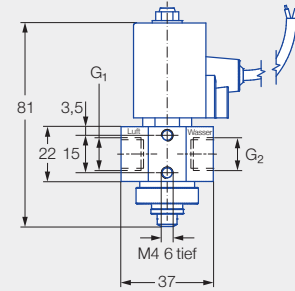

Anschluss Luft G ₁	Anschluss Wasser G ₂	Gewicht [g]
G 1/4 ISO 228	G 1/4 ISO 228	410

Strahl- winkel	Bestell-Nr.		Engster Quer- schnitt Ø [mm]	Flüssigkeitsdruck p [bar]												Strahlabmessungen							
	Type	Mat.-Nr. 16 Edelstahl 1.4305		0,7				1,5				3,0				4,0				p [bar]	p [bar]	B ₁ [mm]	B ₂ [mm]
				p [bar]	V̇ [l/h]	V̇ ₀ [m ³ /h]	p [bar]	V̇ [l/h]	V̇ ₀ [m ³ /h]	p [bar]	V̇ [l/h]	V̇ ₀ [m ³ /h]	p [bar]	V̇ [l/h]	V̇ ₀ [m ³ /h]	p [bar]	V̇ [l/h]	V̇ ₀ [m ³ /h]					
45°	166.414.xx.A2	●	0,7	1,0	7,7	1,3	1,4	14,3	1,5	2,2	22,4	2,0	3,0	25,1	2,5	1,4	0,7	85	125				
				1,2	6,0	1,5	1,6	13,0	1,6	2,6	20,0	2,3	3,4	23,0	2,8	2,4	1,5	100	145				
				1,4	4,2	1,7	1,8	11,6	1,8	3,0	17,7	2,6	3,8	20,9	3,1	3,2	2,0	105	155				
				1,6	2,7	1,9	2,0	10,2	2,0	3,4	15,5	3,0	4,2	18,9	3,5	3,8	3,0	120	170				
				1,8	1,3	2,1	2,2	8,9	2,2	3,8	13,3	3,4	4,6	16,9	3,8	4,6	4,0	130	210				
				-	-	-	2,4	7,4	2,4	4,2	11,0	3,7	5,0	14,9	4,2	-	-	-	-	-			
				-	-	-	2,6	5,9	2,6	4,6	8,8	4,1	5,4	12,8	4,6	-	-	-	-	-			
				-	-	-	2,8	4,6	2,8	5,0	6,6	4,5	5,8	10,8	5,0	-	-	-	-	-			
				-	-	-	3,0	3,2	3,0	5,4	4,3	4,9	6,0	9,8	5,2	-	-	-	-	-			
				-	-	-	3,2	2,1	3,2	5,8	2,5	5,3	-	-	-	-	-	-	-	-			
				-	-	-	3,4	1,1	3,4	6,0	1,6	5,5	-	-	-	-	-	-	-	-			
				-	-	-	2,0	19,0	2,6	2,0	22,0	2,0	3,0	61,8	4,0	3,8	76,1	4,6	1,2	0,7	120	140	
				-	-	-	1,6	12,2	3,4	2,4	18,0	2,4	3,4	51,9	4,8	4,0	70,4	5,1	2,4	1,5	120	170	
				-	-	-	2,0	9,4	4,1	2,8	14,4	2,8	3,8	44,6	5,8	4,2	65,6	5,5	3,2	2,0	120	175	
	-	-	-	2,4	7,1	4,8	3,2	11,3	3,2	4,2	39,0	6,6	4,4	61,3	5,9	3,8	3,0	140	205				
	-	-	-	2,8	5,7	5,4	3,6	8,8	3,6	4,6	33,4	7,4	4,6	57,3	6,4	6,0	4,0	145	205				
	-	-	-	3,2	5,0	6,0	4,0	8,1	3,9	5,0	29,4	8,1	4,8	54,1	6,7	-	-	-	-				
	-	-	-	3,6	3,6	6,6	4,4	6,2	4,3	5,4	25,5	8,9	5,0	51,3	7,2	-	-	-	-				
	-	-	-	4,0	3,2	7,2	4,8	4,6	4,6	5,8	22,0	9,6	5,2	49,3	7,7	-	-	-	-				
	-	-	-	4,4	2,2	7,8	5,2	3,2	4,9	6,0	20,6	9,9	5,4	46,5	8,2	-	-	-	-				
	-	-	-	-	-	-	5,6	1,6	5,3	-	-	-	5,6	43,7	8,6	-	-	-	-				
	-	-	-	-	-	-	5,8	0,8	5,4	-	-	-	5,8	41,3	8,9	-	-	-	-				
	-	-	-	-	-	-	-	-	-	-	-	-	6,0	39,0	9,3	-	-	-	-				





Strahl- winkel	Bestell-Nr.		Engster Quer- schnitt Ø [mm]	Flüssigkeitsdruck p [bar]												Strahlabmessungen				
	Type	Mat.-Nr.		0,7			1,5			3,0			4,0			p Luft [bar]	p Wasser [bar]	B ₁ [mm]	B ₂ [mm]	
		16		p Luft [bar]	V ₀ Wasser [l/h]	V ₀ Luft [m ³ /h]	p Luft [bar]	V ₀ Wasser [l/h]	V ₀ Luft [m ³ /h]	p Luft [bar]	V ₀ Wasser [l/h]	V ₀ Luft [m ³ /h]	p Luft [bar]	V ₀ Wasser [l/h]	V ₀ Luft [m ³ /h]					
60°	166.425.xx.A2	●	0,5	0,8	6,5	1,2	1,4	9,4	1,7	2,4	13,2	2,5	2,4	16,1	2,5	1,2	0,7	155	195	
				1,2	5,5	1,6	1,8	8,7	2,1	2,6	12,9	2,7	2,8	15,5	2,9	2,2	1,5	165	255	
				1,6	4,7	1,9	2,2	7,9	2,4	3,0	12,3	3,0	3,2	15,0	3,2	3,0	2,0	170	265	
				2,0	4,0	2,3	2,6	7,2	2,7	3,4	11,8	3,4	3,6	14,5	3,5	3,4	3,0	200	330	
				2,4	3,2	2,6	3,0	6,4	3,1	3,8	11,1	3,7	4,0	13,9	3,8	5,6	4,0	200	330	
				2,8	2,6	2,9	3,4	5,7	3,4	4,2	10,4	4,0	4,4	13,4	4,1	-	-	-	-	-
				3,0	2,2	3,1	3,8	5,1	3,7	4,6	9,8	4,3	4,8	12,8	4,5	-	-	-	-	-
				-	-	-	4,0	4,8	3,9	5,0	9,2	4,6	5,2	12,2	4,8	-	-	-	-	-
				-	-	-	4,4	4,2	4,2	5,4	8,6	5,0	5,6	11,7	5,1	-	-	-	-	-
				-	-	-	4,8	3,6	4,5	5,8	8,1	5,3	6,0	11,2	5,4	-	-	-	-	-
	-	-	-	5,2	2,8	4,8	6,0	7,8	5,4	-	-	-	-	-	-	-	-			
	-	-	-	5,6	2,2	5,1	-	-	-	-	-	-	-	-	-	-	-			
	-	-	-	6,0	1,6	5,5	-	-	-	-	-	-	-	-	-	-	-			
	-	-	-	-	-	-	-	-	-	-	-	-	-	-	-	-	-			
	166.452.xx.A2	●	1,5	1,0	18,8	3,9	1,8	31,0	5,3	3,2	50,1	7,7	3,8	70,7	8,2	1,0	0,7	130	185	
				1,4	8,6	5,7	2,0	25,4	6,3	3,6	39,5	9,4	4,2	58,6	9,6	1,8	1,5	150	240	
				1,8	7,4	7,0	2,2	20,1	7,2	4,0	31,3	11,2	4,6	48,6	11,2	2,6	2,0	155	245	
				2,2	4,1	8,4	2,4	15,5	8,0	4,4	24,0	12,9	5,0	41,2	13,1	3,6	3,0	175	280	
				2,6	1,0	9,8	2,6	12,4	8,9	4,8	17,7	14,5	5,4	33,6	14,8	5,0	4,0	180	285	
				2,8	0,1	10,3	2,8	10,4	9,6	5,2	13,4	16,0	5,8	27,5	16,4	-	-	-	-	-
-				-	-	-	-	-	5,6	10,6	17,5	6,0	24,4	17,2	-	-	-	-	-	
-				-	-	-	-	-	6,0	8,6	18,8	-	-	-	-	-	-	-	-	
166.433.xx.A2	●	0,4	1,0	11,6	2,0	1,8	18,3	2,8	3,0	31,0	3,7	3,8	37,5	4,4	1,4	0,7	150	210		
			1,2	8,1	2,4	2,0	15,3	3,2	3,4	25,4	4,4	4,2	32,4	5,0	2,2	1,5	185	255		
			1,4	5,3	2,8	2,2	12,2	3,6	3,8	20,6	5,1	4,6	27,7	5,7	3,0	2,0	205	300		
			1,6	3,7	3,2	2,4	9,8	4,0	4,2	16,3	5,9	5,0	23,4	6,5	3,8	4,0	300	485		
			-	-	-	2,6	7,6	4,3	4,6	12,5	6,6	5,4	19,4	7,2	5,2	4,0	260	395		
			-	-	-	2,8	5,9	4,7	5,0	9,3	7,3	5,8	15,9	7,9	-	-	-	-	-	
			-	-	-	3,0	4,4	5,0	5,4	6,5	8,0	6,0	14,2	8,3	-	-	-	-	-	

Bestell- Type + Material-Nr. = Bestell-Nr.
 beispiel: 166.425.xx.A2 + 16 = 166.425.16.A2





Pneumatik-Zerstäuberdüsen, Flachstrahl, Druckprinzip, Außenmischung Baureihe 166.6



Eigenschaften:

- Version mit Magnetventil
- Feine Flachstrahlzerstäubung
- Flüssigkeitsdruckprinzip
- Außenmischung

Anwendung:

- Bandbefeuchtung
- Kühlung
- Warenbefeuchtung
- Zerstäubung viskoser Medien

Technische Daten:

- Betriebsdruck: 0–6 bar
- Spannung: 24 V DC
- Leistung: 8 W
- Schaltfrequenz: ca. 500/min
- Schutzart: IP 67
- Umgebungstemperatur: +10 °C /+50 °C
- Kabellänge: 1.000 mm
- Dichtwerkstoff: EPDM



Baureihe 166.6

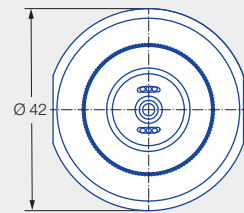
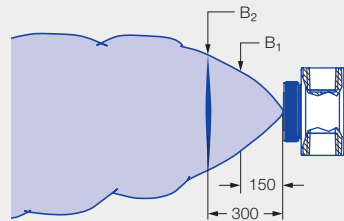
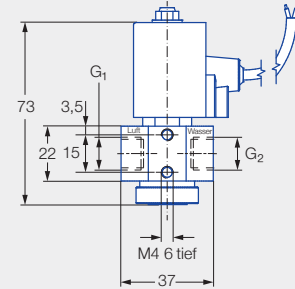

Anschluss Luft G ₁	Anschluss Wasser G ₂	Gewicht [g]
G 1/4 ISO 228	G 1/4 ISO 228	410

Strahl- winkel	Bestell-Nr.		Engster Quer- schnitt Ø [mm]	Flüssigkeitsdruck p [bar]												Strahlabmessungen							
	Type	Mat.-Nr. 16 Edelstahl 1.4305		0,07				0,15				0,30				0,35				p Luft [bar]	p Wasser [bar]	B ₁ [mm]	B ₂ [mm]
				p Luft [bar]	v̇ Wasser [l/h]	v̇ _n Luft [m ³ /h]	p Luft [bar]	v̇ Wasser [l/h]	v̇ _n Luft [m ³ /h]	p Luft [bar]	v̇ Wasser [l/h]	v̇ _n Luft [m ³ /h]	p Luft [bar]	v̇ Wasser [l/h]	v̇ _n Luft [m ³ /h]								
45°	166.616.xx.A2	●	0,40	0,80	1,68	2,50	0,80	2,43	2,40	0,80	3,42	2,50	1,00	3,69	2,80	1,40	0,07	80	115				
				1,20	1,80	3,10	1,00	2,46	2,90	1,20	3,48	3,10	1,40	3,81	3,40	2,20	0,15	90	130				
				1,60	1,92	3,70	1,40	2,58	3,60	1,60	3,51	3,70	1,80	3,87	4,00	3,20	0,20	90	135				
				2,00	2,10	4,30	1,80	2,61	4,20	2,00	3,63	4,30	2,20	3,84	4,60	4,00	0,30	95	145				
				2,40	2,07	4,90	2,20	2,76	4,80	2,40	3,63	4,90	2,60	3,90	5,20	5,00	0,35	100	145				
				2,80	2,19	5,50	2,60	2,73	5,40	2,80	3,63	5,50	3,00	3,93	5,80	-	-	-	-	-			
				3,20	2,19	6,10	3,00	2,73	6,00	3,20	3,63	6,10	3,40	3,90	6,40	-	-	-	-	-			
				3,60	2,22	6,70	3,60	2,76	6,70	3,60	3,66	6,70	3,80	3,93	7,00	-	-	-	-	-			
				4,00	2,22	7,30	4,00	2,76	7,30	4,00	3,69	7,30	4,20	3,96	7,60	-	-	-	-	-			
				4,40	2,22	7,90	4,40	2,76	7,90	4,40	3,69	7,90	4,60	3,93	8,20	-	-	-	-	-			
	4,80	2,22	8,50	4,80	2,76	8,50	4,80	3,69	8,40	5,00	3,93	8,80	-	-	-	-	-						
	5,20	2,22	9,10	5,20	2,76	9,10	5,20	3,66	9,10	5,40	3,93	9,40	-	-	-	-	-						
	5,60	2,22	9,60	5,60	2,76	9,70	5,60	3,66	9,60	5,80	3,87	10,00	-	-	-	-	-						
	6,00	2,22	10,20	6,00	2,73	10,20	6,00	3,66	10,20	6,00	3,87	10,20	-	-	-	-	-						
	0,80	5,25	2,40	0,80	7,29	2,40	1,20	10,11	3,10	1,60	11,07	3,70	1,40	0,07	95	135							
	1,20	5,64	3,10	1,20	7,44	3,10	1,60	10,23	3,70	2,00	11,22	4,30	2,20	0,15	100	150							
	1,60	5,79	3,70	1,60	7,62	3,70	2,00	10,38	4,30	2,40	11,28	4,90	3,20	0,20	105	160							
	2,00	6,18	4,30	2,00	7,86	4,30	2,40	10,47	4,90	2,80	11,31	5,50	4,00	0,30	105	160							
	2,40	6,24	4,90	2,40	7,92	4,90	2,80	10,59	5,50	3,20	11,43	6,10	5,00	0,35	105	160							
	2,80	6,27	5,50	2,80	8,04	5,50	3,20	10,59	6,10	3,60	11,46	6,60	-	-	-	-	-						
3,20	6,39	6,10	3,20	8,13	6,10	3,60	10,62	6,70	4,00	11,43	7,20	-	-	-	-	-							
3,60	6,42	6,60	3,60	8,13	6,70	4,00	10,62	7,20	4,40	11,37	7,80	-	-	-	-	-							
4,00	6,45	7,20	4,00	8,13	7,20	4,40	10,62	7,80	4,80	11,37	8,40	-	-	-	-	-							
4,40	6,42	7,80	4,40	8,07	7,80	4,80	10,59	8,40	5,20	11,34	9,00	-	-	-	-	-							
4,80	6,30	8,40	4,80	8,04	8,40	5,20	10,56	9,00	5,60	11,22	9,60	-	-	-	-	-							
5,20	6,24	9,00	5,20	7,86	9,00	5,60	10,50	9,60	6,00	11,16	10,10	-	-	-	-	-							
5,60	6,09	9,60	5,60	7,83	9,60	6,00	10,35	10,20	-	-	-	-	-	-	-	-							
6,00	5,85	10,20	6,00	7,59	10,20	-	-	-	-	-	-	-	-	-	-	-	-						





Strahlwinkel	Bestell-Nr.		Engster Querschnitt Ø [mm]	Flüssigkeitsdruck p [bar]												Strahlabmessungen				
	Type	Mat.-Nr.		0,07			0,15			0,30			0,35			p Luft [bar]	p Wasser [bar]	B ₁ [mm]	B ₂ [mm]	
		16		p Luft [bar]	V _n Wasser [l/h]	V _n Luft [m ³ /h]	p Luft [bar]	V _n Wasser [l/h]	V _n Luft [m ³ /h]	p Luft [bar]	V _n Wasser [l/h]	V _n Luft [m ³ /h]	p Luft [bar]	V _n Wasser [l/h]	V _n Luft [m ³ /h]					
60°	166.626.xx.A2	●	0,40	0,80	1,83	2,80	0,80	2,49	2,80	0,80	3,48	2,80	0,80	3,78	2,80	1,60	0,07	85	135	
				1,20	1,98	3,60	1,20	2,58	3,50	1,20	3,60	3,50	1,20	3,87	3,60	2,40	0,15	90	140	
				1,60	2,10	4,30	1,60	2,70	4,20	1,60	3,66	4,30	1,60	3,90	4,20	3,20	0,20	90	140	
				2,00	2,16	4,90	2,00	2,82	4,90	2,00	3,69	4,90	2,00	3,96	4,90	4,00	0,30	100	145	
				2,40	2,25	5,60	2,40	2,85	5,60	2,40	3,69	5,60	2,40	3,96	5,60	5,20	0,35	105	150	
				2,80	2,34	6,30	2,80	2,88	6,30	2,80	3,72	6,30	2,80	4,02	6,30	-	-	-	-	-
				3,20	2,31	7,00	3,20	2,88	7,00	3,20	3,78	7,00	3,20	3,99	7,00	-	-	-	-	-
				3,60	2,34	7,60	3,60	2,88	7,70	3,60	3,78	7,60	3,60	4,02	7,70	-	-	-	-	-
				4,00	2,40	8,40	4,00	2,94	8,40	4,00	3,81	8,30	4,00	4,05	8,30	-	-	-	-	-
				4,40	2,40	9,00	4,40	2,91	9,00	4,40	3,81	9,00	4,40	4,02	9,00	-	-	-	-	-
				4,80	2,40	9,70	4,80	2,97	9,70	4,80	3,81	9,70	4,80	4,08	9,70	-	-	-	-	-
				5,20	2,43	10,40	5,20	2,97	10,40	5,20	3,81	10,40	5,20	4,05	10,40	-	-	-	-	-
	5,60	2,43	11,20	5,60	2,97	11,10	5,60	3,81	11,10	5,60	4,05	11,00	-	-	-	-	-			
	6,00	2,43	11,80	6,00	2,97	11,80	6,00	3,81	11,80	6,00	4,05	11,80	-	-	-	-	-			
	166.682.xx.A2	●	1,50	1,00	22,41	7,50	1,40	28,95	9,30	1,80	41,22	11,10	2,00	44,04	11,80	1,60	0,07	110	155	
				1,40	20,19	9,30	1,80	26,07	10,90	2,20	34,92	12,60	2,40	39,09	13,40	2,40	0,15	120	155	
				1,80	18,75	11,00	2,20	23,94	12,50	2,60	33,18	14,20	2,80	35,16	15,10	3,20	0,20	120	160	
				2,20	17,88	12,50	2,60	22,23	14,30	3,00	30,45	15,90	3,20	32,22	16,70	4,00	0,30	120	165	
				2,60	17,10	14,20	3,00	21,12	15,90	3,40	28,29	17,50	3,60	30,18	18,30	5,20	0,35	120	175	
				3,00	16,47	15,90	3,40	20,10	17,50	3,80	26,64	19,10	4,00	28,32	19,90	-	-	-	-	-
				3,40	16,08	17,50	3,80	19,44	19,10	4,20	25,35	20,70	4,40	26,94	21,50	-	-	-	-	-
				3,80	15,90	19,10	4,20	18,99	20,70	4,60	24,24	22,30	4,80	25,59	23,10	-	-	-	-	-
				4,20	15,90	20,70	4,60	18,45	22,30	5,00	23,13	24,00	5,20	24,36	24,80	-	-	-	-	-
				4,60	15,81	22,30	5,00	18,18	24,00	5,40	22,14	25,50	5,60	23,28	26,40	-	-	-	-	-
				5,00	15,21	23,90	5,40	17,25	25,40	5,80	21,12	27,20	6,00	22,17	28,00	-	-	-	-	-
				5,40	13,92	25,50	5,80	15,72	27,20	6,00	20,67	28,00	-	-	-	-	-	-	-	-
	5,80	12,09	27,20	6,00	14,91	28,00	-	-	-	-	-	-	-	-	-	-	-			
	6,00	11,07	28,00	-	-	-	-	-	-	-	-	-	-	-	-	-	-			
	166.691.xx.A2	●	2,50	1,40	52,00	13,80	2,00	67,30	17,50	2,60	92,30	21,20	2,60	102,10	21,20	1,60	0,07	150	200	
				1,80	50,00	16,30	2,40	64,60	20,10	3,00	87,70	23,60	3,00	97,20	23,70	2,40	0,15	160	205	
				2,20	48,60	18,80	2,80	62,00	22,50	3,40	84,30	26,00	3,40	92,50	26,10	3,20	0,20	160	205	
				2,60	47,50	21,30	3,20	60,40	24,90	3,80	80,70	28,50	3,80	88,40	28,50	4,00	0,30	160	210	
				3,00	46,50	23,70	3,60	58,00	27,30	4,20	77,00	30,90	4,20	85,20	31,00	5,20	0,35	150	210	
				3,40	45,40	26,10	4,00	56,20	29,80	4,60	74,40	33,40	4,60	81,30	33,40	-	-	-	-	-
				3,80	44,40	28,60	4,40	54,20	32,10	5,00	71,10	35,90	5,00	78,20	35,80	-	-	-	-	-
				4,20	42,90	31,00	4,80	52,40	34,70	5,40	68,10	38,30	5,40	74,30	38,20	-	-	-	-	-
4,60				41,50	33,40	5,20	49,90	37,10	5,80	64,30	40,80	5,80	71,10	40,70	-	-	-	-	-	
5,00				39,90	35,80	5,60	48,10	39,50	6,00	63,20	42,00	6,00	68,90	41,90	-	-	-	-	-	
5,40				38,90	38,30	6,00	46,40	42,00	-	-	-	-	-	-	-	-	-	-	-	
5,60				38,50	39,40	-	-	-	-	-	-	-	-	-	-	-	-	-	-	

Bestell- Type + Material-Nr. = Bestell-Nr.
 beispiel: 166.626.xx.A2 + 16 = 166.626.16.A2



Zubehör für Pneumatik-Zerstäuberdüsen Baureihen 136.1 bis 136.6



Übersicht Zubehör

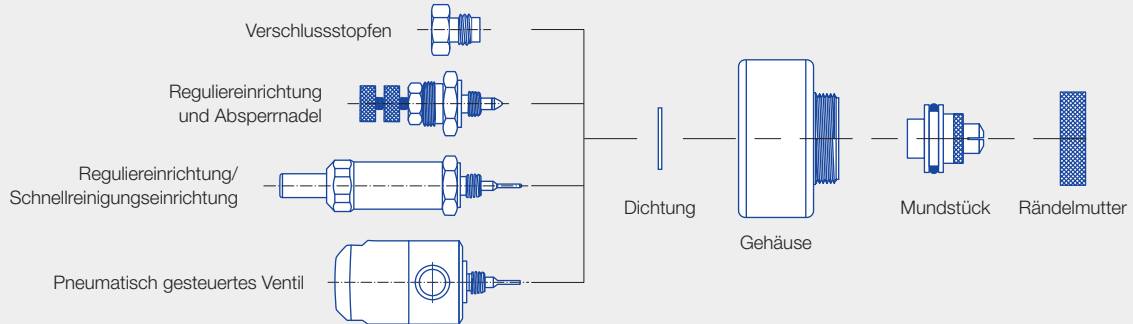

Reguliereinrichtung und Absperrnadel

Ermöglicht die manuelle Regulierung des Volumenstroms und das Verschließen der Düse.

Werkstoff: Edelstahl 1.4305
Gewicht: 33 g

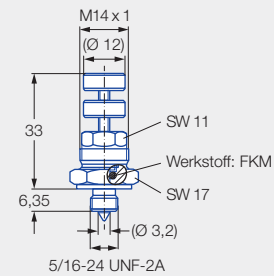

Bestell-Nr.

Type

013.600.16

Passend für
alle Düsen der
Baureihe 136

Reguliereinrichtung mit Schnellreinigungsnadel

Ermöglicht die manuelle Regulierung des Volumenstroms und die Reinigung der Düsenbohrung.

Werkstoff: Edelstahl 1.4305
Gewicht: 75 g

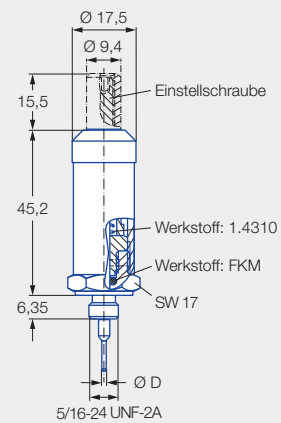

Bestell-Nr.

Type

013.601.16.30

013.602.16.30

013.603.16.30

013.604.16.30

013.605.16.30

013.606.16.30

Für Düsen

136.xx1

136.xx2

136.xx3

136.xx4

136.xx5

136.xx6

Nadeldurchmesser
D
[mm]

2,1

1,2

0,8

0,6

0,4

0,3





Pneumatisch gesteuertes Ventil. Öffnungsdruck 2,1 bar, max. 180 Schaltspiele/min.

Externe Steuerung über separaten Druckluftanschluss für das Ein- und Ausschalten der Düse.

Werkstoff: Edelstahl 1.4305
Gewicht: 230 g

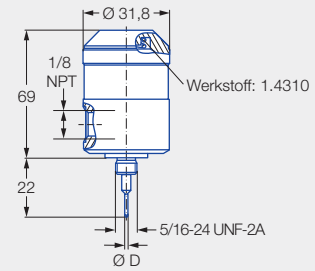

Bestell-Nr.	Für Düsen	Nadeldurchmesser D [mm]
Type		
013.601.16.10	136.xx1	2,1
013.602.16.10	136.xx2	1,2
013.603.16.10	136.xx3	0,8
013.604.16.10	136.xx4	0,6
013.605.16.10	136.xx5	0,4
013.606.16.10	136.xx6	0,3

➤ Pneumatik-Zerstäuberdüsen, Vollkegel, Ansaugprinzip, Innenmischung Baureihe 140



Eigenschaften:

- Besonders feine Vollkegelzerstäubung
- Ansaugprinzip
- Innenmischung
- Reguliereinrichtung integriert
- Werkstoff: Messing 2.0401

Anwendung:

- Schmierung
- Kühlung
- Luftbefeuchtung



Baureihe 140

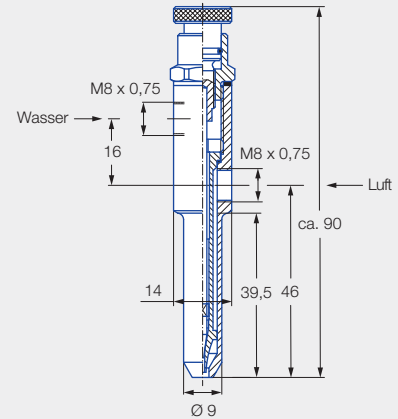

Mat.-Nr.	Gewicht [g]
30	70

Strahlwinkel	Bestell-Nr. Type	Engster Querschnitt Ø [mm]		Hs Saughöhe [mm WS]	Volumenstrom V̇ W = Wasser V̇ _n L = Luft p [bar] Luftdruck							
		Wasser	Luft		0,5		1,0		2,0		3,0	
					V̇ W [l/h]	V̇ _n L [m³/h]	V̇ W [l/h]	V̇ _n L [m³/h]	V̇ W [l/h]	V̇ _n L [m³/h]	V̇ W [l/h]	V̇ _n L [m³/h]
20°-30°	140.252.30.01	0,50	0,75	500	-	-	4,50	4,00	8,00	6,00	10,50	8,00
		0,50	0,75	200	4,50	2,50	7,00	4,00	10,00	6,00	12,00	8,00

Funktionszeichnung/Zubehör

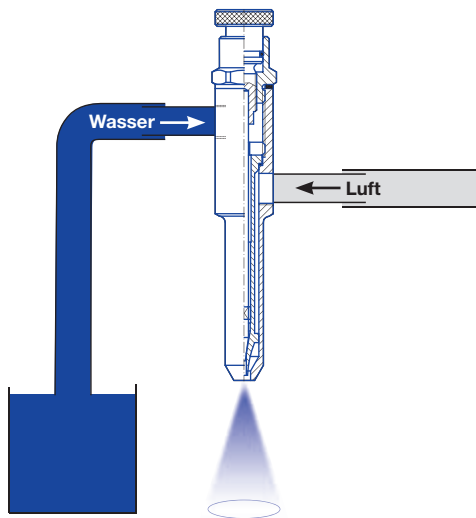

Zubehör:

- Dichtung
014.040.72
7,8 x 12 x 1 (EWP 210)
- Nippel
014.010.30.04
(Material: Messing 2.0401)
Gewicht: 17 g

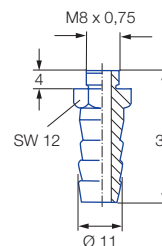

➤ Pneumatik-Zerstäuberdüsen, zum Zerstäuben viskoser Medien Baureihe 176 ViscoMist



Die ViscoMist Baureihe ermöglicht die getrennte Regelung von Zerstäubungs- und Strahlluft. Strahlwinkel und Tropfengröße lassen sich so individuell anpassen.

Die integrierte, pneumatisch angesteuerte Absperrnadel öffnet bzw. schließt die Flüssigkeitsöffnung und reinigt sie zudem bei jedem Schließvorgang. Dies ist beim Versprühen viskoser Medien von besonderem Vorteil. Dank ihres modularen Aufbaus lassen sich die Düsen der Baureihe ViscoMist optimal dem jeweiligen Sprühprozess anpassen. Dazu genügt es, die volumen- und strahlformrelevanten Düsenbauteile auszutauschen. Das Gehäuse bleibt dasselbe.



Baureihe 176 ViscoMist

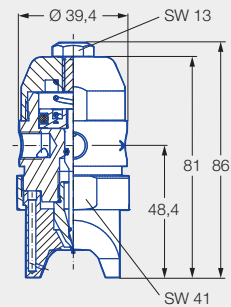
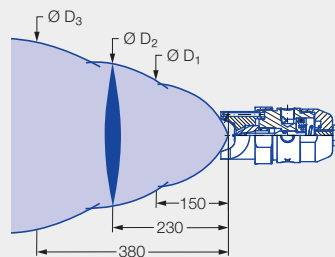

Außenmischende Düse für viskose Medien, z. B. bei:

- Beschichtungsprozessen
- Befeuchtung
- Schmierung
- Glasieren
- Desinfizieren

Eine Düse – mehrere Strahlformen:

- Strahlformen
 - Vollstrahl
 - Vollkegel
 - Flachstrahl
- Einzelregelung von Flüssigkeit, Zerstäubungs- und Strahlluft
- Zirkulation des Fluides möglich (Ausführung mit 5 Anschlüssen)

Düsengrößen:

- Ø 0,38 mm bis 2,54 mm

Ventil:

- Drucklos geschlossen, dadurch störungssicher

Steuerluftdruck:

- Min. 2 bar, max. 3 bar

Max. Schalthäufigkeit:

- 180 Schaltspiele/min (kurzfristig)

Anschlussgewinde:

- G 1/8 ISO 228
- NPT-Gewinde auf Anfrage

Gewicht:

- 550 g

Material:

- 1Y (Edelstahl 1.4404 [316L])

Volumenstrombereich:

- Wasser: 7,8 bis 307,0 l/h, bei 2 bar
- Luft: 7,5 bis 28,4 m³/h i. N., bei 2 bar

Zerstäubungsluft/Steuerluft/Strahlluft:

- Die Zerstäubungsluft bewirkt die Zerstäubung der Flüssigkeit an der Düsenöffnung. Durch die Strahlluft kann die Sprühcharakteristik an die Anwendung angepasst werden. Durch die Steuerluft wird die Düse aktiviert.

Gehäusevarianten

Gehäusevariante 2

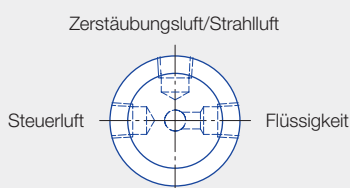

Ausführung mit 3 Anschlüssen

Gehäusevariante 4

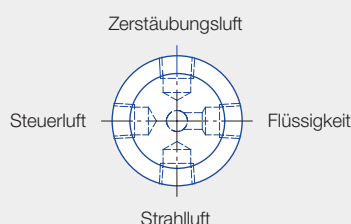

Ausführung mit 4 Anschlüssen

Gehäusevariante 5

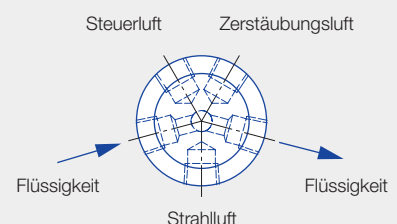

Ausführung mit 5 Anschlüssen

Bestell-Nr.	Engster Querschnitt Ø [mm]	Flüssigkeit		Luft			Strahlabmessungen [mm] im Abstand von D ₁ , D ₂ und D ₃																
		Flüssigkeitsdruck p [bar]	ṽ Wasser [l/h]	Luftdruck p Luft [bar]	Zerstäubungsluft [m³/h]	Strahlluft [m³/h]	Zerstäubungsluft [bar]	Flüssigkeitsdruck p [bar]	Strahlluft [bar]														
									0,00*			0,35			0,70			1,00			1,50		
176.201.1Y.11.00 176.401.1Y.11.00 176.501.1Y.11.00	0,38	0,15	1,89	0,15	0,75	1,00	0,30	0,35	40	60	100	150	180	200	180	230	290	180	230	250	180	230	280
		0,30	2,80	0,30	1,09	1,44		0,70	40	50	80	150	200	280	200	270	330	230	280	330	230	280	330
		0,70	4,39	0,70	1,63	2,28		1,00	-	-	-	170	200	280	200	300	380	230	300	360	250	300	380
		1,00	5,49	1,00	2,02	2,89		1,50	-	-	-	170	200	360	200	250	340	250	300	360	280	320	380
		1,35	6,40	1,35	2,38	3,45	1,00	0,35	40	60	100	100	130	170	130	180	230	150	230	280	170	220	300
		1,70	7,19	1,70	2,77	3,99		0,70	40	60	100	80	110	180	130	180	230	150	200	230	180	230	280
		2,00	7,91	2,00	3,11	4,55		1,00	30	40	80	80	130	180	130	180	250	150	230	280	180	230	330
		2,40	8,63	2,40	3,48	5,11		1,50	-	-	-	100	150	200	150	190	250	180	250	360	190	270	360
		2,75	9,24	2,75	3,87	5,67	2,00	0,35	40	60	100	50	80	110	90	130	150	100	150	190	150	200	240
		3,15	9,80	3,15	4,23	6,24		0,70	40	60	90	60	90	140	80	100	140	110	180	230	150	200	250
		3,50	10,33	3,50	4,60	6,78		1,00	40	60	90	70	90	140	100	130	190	130	200	250	150	200	250
		4,00	11,17	4,00	5,22	7,70		1,50	-	-	-	60	80	130	110	140	180	140	190	230	180	230	300
176.202.1Y.11.00 176.402.1Y.11.00 176.502.1Y.11.00	0,58	0,15	4,05	0,15	0,78	1,00	0,30	0,35	40	60	100	140	190	270	220	250	300	190	240	280	200	230	300
		0,30	5,90	0,30	1,10	1,44		0,70	-	-	-	180	240	250	230	300	360	280	330	410	300	340	410
		0,70	9,27	0,70	1,67	2,28		1,00	-	-	-	150	200	230	250	290	430	300	340	460	300	370	560
		1,00	11,47	1,00	2,06	2,89		1,50	-	-	-	-	-	-	250	290	360	280	340	430	360	410	480
		1,35	13,32	1,35	2,43	3,45	1,00	0,35	40	50	90	110	140	150	130	170	230	150	180	230	180	220	250
		1,70	14,99	1,70	2,79	3,99		0,70	40	60	90	110	130	190	140	180	240	170	220	250	200	230	280
		2,00	16,43	2,00	3,14	4,55		1,00	-	-	-	100	140	200	170	200	280	190	230	330	200	250	330
		2,40	17,90	2,40	3,52	5,11		1,50	-	-	-	-	-	-	170	200	300	200	250	360	250	300	380
		2,75	19,23	2,75	3,91	5,67	2,00	0,35	40	50	80	60	80	110	90	130	170	110	150	180	130	200	230
		3,15	20,44	3,15	4,28	6,24		0,70	40	40	80	70	100	130	110	140	170	140	180	190	150	200	250
		3,50	21,57	3,50	4,66	6,78		1,00	30	50	90	70	100	130	100	150	180	130	180	230	150	200	250
		4,00	23,32	4,00	5,22	7,70		1,50	-	-	-	70	100	150	110	150	230	130	180	240	170	230	300
176.203.1Y.11.00 176.403.1Y.11.00 176.503.1Y.11.00	0,79	0,15	8,36	0,15	0,48	1,00	0,30	0,35	-	-	-	230	300	410	330	410	480	330	410	510	300	380	460
		0,30	12,38	0,30	0,71	1,44		0,70	-	-	-	230	280	330	300	360	510	410	480	610	430	580	740
		0,70	19,19	0,70	1,16	2,28		1,00	-	-	-	-	-	-	330	410	530	410	460	640	460	530	710
		1,00	23,77	1,00	1,46	2,89		1,50	-	-	-	-	-	-	280	360	460	380	460	610	410	510	580
		1,35	27,59	1,35	1,65	3,45	1,00	0,35	40	60	100	150	200	270	170	230	280	230	300	380	280	360	410
		1,70	31,04	1,70	1,89	3,99		0,70	-	-	-	150	200	250	230	300	380	300	360	460	330	380	430
		1,50	-	-	-	-		1,00	-	-	-	-	-	-	230	280	410	300	380	510	300	410	480

* Ohne Strahlluft wird ein kegelförmiges Sprühbild erzeugt.





Bestell-Nr.	Engster Querschnitt Ø [mm]	Flüssigkeit		Luft			Strahlabmessungen [mm] im Abstand von D ₁ , D ₂ und D ₃																			
		Flüssigkeitsdruck p [bar]	ṽ Wasser [l/h]	Luftdruck p Luft [bar]	Zerstäubungsluft [m ³ /h]	Strahlluft [m ³ /h]	Zerstäubungsluft [bar]	Flüssigkeitsdruck p [bar]	Strahlluft [bar]																	
									0,00*			0,35			0,70			1,00			1,50					
									Ø D ₁ = 150 mm	Ø D ₂ = 230 mm	Ø D ₃ = 380 mm	Ø D ₁ = 150 mm	Ø D ₂ = 230 mm	Ø D ₃ = 380 mm	Ø D ₁ = 150 mm	Ø D ₂ = 230 mm	Ø D ₃ = 380 mm	Ø D ₁ = 150 mm	Ø D ₂ = 230 mm	Ø D ₃ = 380 mm	Ø D ₁ = 150 mm	Ø D ₂ = 230 mm	Ø D ₃ = 380 mm			
Type																										
176.203.1Y.11.00 176.403.1Y.11.00 176.503.1Y.11.00	0,79	2,00	33,99	2,00	2,14	4,55	2,00	0,35	30	60	80	100	140	180	150	200	240	190	230	300	200	230	280			
		2,40	36,75	2,40	2,40	5,11		0,70	-	-	-	130	150	200	170	230	330	230	300	380	250	300	360			
		2,75	39,44	2,75	2,65	5,67		1,00	-	-	-	130	180	200	180	230	330	230	300	410	250	320	410			
		4,00	47,92	4,00	3,65	7,70		1,50	-	-	-	-	-	-	180	230	330	240	300	430	250	330	430			
		3,15	41,98	3,15	2,94	6,24	2,75	0,35	40	60	90	100	130	180	140	180	230	170	200	280	190	230	300			
		3,50	44,32	3,50	3,16	6,78		0,70	-	-	-	110	150	200	150	200	250	180	230	300	230	280	380			
								1,00	-	-	-	-	-	-	180	230	300	200	250	360	230	280	380			
								1,50	-	-	-	-	-	-	180	230	330	230	280	380	230	290	410			
		176.204.1Y.11.00 176.404.1Y.11.00 176.504.1Y.11.00	1,07	0,15	16,88	0,15	2,34	2,04	0,30	0,35	-	-	-	150	200	300	300	410	460	330	410	560	300	410	510	
				0,30	24,38	0,30	3,47	2,94		0,70	-	-	-	-	-	-	300	380	1.040	360	430	530	410	480	640	
				0,70	37,28	0,70	5,59	4,60		1,00	-	-	-	-	-	-	250	380	510	360	460	580	410	510	690	
				4,00	47,92	4,00	3,65	7,70		1,50	-	-	-	-	-	-	250	380	480	330	380	530	410	510	660	
1,00	45,80			1,00	7,32	5,81	1,00	0,35	40	60	80	110	140	190	150	200	250	200	250	330	250	300	430			
1,35	52,91			1,35	8,83	6,90		0,70	-	-	-	100	140	230	170	200	270	220	270	380	250	330	430			
1,70	59,20			1,70	10,19	7,99		1,00	-	-	-	100	130	180	150	190	300	220	250	380	250	300	480			
4,00	47,92			4,00	3,65	7,70		1,50	-	-	-	-	-	-	150	200	280	200	250	410	240	300	460			
2,00	64,99			2,00	11,55	9,06	2,00	0,35	40	60	90	80	100	140	100	130	180	110	170	230	150	190	280			
2,40	70,55			2,40	12,91	10,13		0,70	-	-	-	80	100	150	100	130	200	130	170	230	150	200	280			
2,75	75,51			2,75	14,31	11,21		1,00	-	-	-	70	100	150	100	140	200	130	180	250	150	200	280			
4,00	47,92			4,00	3,65	7,70		1,50	-	-	-	70	100	150	110	140	230	130	170	250	150	200	300			
3,15	80,28			3,15	15,63	12,27	2,75	0,35	50	70	100	70	90	140	90	120	180	110	140	200	140	180	250			
3,50	84,90			3,50	17,11	13,32		0,70	40	70	100	60	90	140	100	130	180	110	150	230	140	190	250			
								1,00	-	-	-	70	90	140	100	120	190	110	160	250	150	180	280			
4,00	91,56			4,00	19,49	15,12		1,50	-	-	-	70	100	150	100	120	180	110	150	230	140	190	300			
176.205.1Y.11.00 176.405.1Y.11.00 176.505.1Y.11.00	1,32	0,15	24,60	0,15	2,17	2,04	0,30	0,35	-	-	-	230	330	460	360	460	530	410	530	640	460	530	660			
		0,30	35,35	0,30	3,23	2,94		0,70	-	-	-	-	-	-	330	460	580	410	510	660	410	480	610			
		0,70	54,31	0,70	5,16	4,60		1,00	-	-	-	-	-	-	330	410	480	360	460	560	430	560	740			
		4,00	47,92	4,00	3,65	7,70		1,50	-	-	-	-	-	-	-	-	-	380	510	660	460	580	810			
		1,00	66,62	1,00	6,75	5,81	1,00	0,35	-	-	-	130	170	230	180	230	380	230	290	430	190	360	510			
		1,35	76,46	1,35	8,00	6,90		0,70	-	-	-	110	170	230	180	230	330	220	290	410	190	360	510			
		1,70	86,18	1,70	9,17	7,99		1,00	-	-	-	-	-	-	190	240	360	230	300	430	270	340	480			
		4,00	47,92	4,00	3,65	7,70		1,50	-	-	-	-	-	-	170	220	300	220	300	410	250	330	480			
		2,00	94,81	2,00	10,35	9,06	2,00	0,35	40	60	90	80	100	150	110	140	200	140	180	250	170	220	330			
		2,40	102,95	2,40	11,55	10,13		0,70	-	-	-	70	100	150	110	150	230	130	180	280	170	230	360			
		2,75	110,48	2,75	12,78	11,21		1,00	-	-	-	80	100	150	110	140	220	140	190	280	170	230	360			
		4,00	47,92	4,00	3,65	7,70		1,50	-	-	-	70	100	150	110	150	200	140	190	300	170	230	360			
		3,15	117,52	3,15	14,00	12,27	2,75	0,35	40	60	100	80	100	150	90	130	200	110	150	230	140	180	280			
		3,50	124,15	3,50	15,10	13,32		0,70	-	-	-	60	90	140	100	130	200	110	170	250	150	200	300			
								1,00	-	-	-	60	90	130	100	130	200	120	170	240	150	200	300			
		4,00	134,14	4,00	17,23	15,12		1,50	-	-	-	60	90	150	100	130	200	110	180	250	150	200	300			

* Ohne Strahlluft wird ein kegelförmiges Sprühbild erzeugt.

Bestell-Nr.	Engster Querschnitt Ø [mm]	Flüssigkeit		Luft			Strahlmessungen [mm] im Abstand von D ₁ , D ₂ und D ₃																				
		Flüssigkeitsdruck p [bar]	V̇ Wasser [l/h]	Luftdruck p Luft [bar]	Zerstäubungsluft [m³/h]	Strahlluft [m³/h]	Zerstäubungsluft [bar]	Flüssigkeitsdruck p [bar]	Strahlluft [bar]																		
									0,70			1,00			1,40			1,75			2,00						
									Ø D ₁ = 150 mm	Ø D ₂ = 230 mm	Ø D ₃ = 380 mm	Ø D ₁ = 150 mm	Ø D ₂ = 230 mm	Ø D ₃ = 380 mm	Ø D ₁ = 150 mm	Ø D ₂ = 230 mm	Ø D ₃ = 380 mm	Ø D ₁ = 150 mm	Ø D ₂ = 230 mm	Ø D ₃ = 380 mm	Ø D ₁ = 150 mm	Ø D ₂ = 230 mm	Ø D ₃ = 380 mm				
Type																											
176.206.1Y.11.00 176.406.1Y.11.00 176.506.1Y.11.00	1,70	0,15	41,71	0,15	1,53	2,04	1,00	0,35	220	330	510	280	410	610	360	460	660	-	-	-	-	-	-				
		0,30	59,54	0,30	2,24	2,94		0,70	240	360	530	330	430	660	360	510	760	-	-	-	-	-	-				
		0,70	90,88	0,70	3,47	4,60		1,00	250	360	510	300	430	610	360	510	690	-	-	-	-	-	-				
		1,00	111,73	1,00	4,35	5,81		1,50	-	-	-	300	380	560	330	460	610	-	-	-	-	-	-				
		1,35	128,99	1,35	5,15	6,90	2,00	0,35	150	230	330	200	280	410	230	300	460	230	330	460	250	330	430				
		1,70	144,21	1,70	5,95	7,99		0,70	180	230	300	200	250	380	230	300	460	250	360	480	280	360	510				
		2,00	157,91	2,00	6,71	9,06		1,00	150	230	330	180	250	380	230	300	430	250	330	480	280	360	530				
		2,40	170,48	2,40	7,53	10,13		1,50	-	-	-	180	250	360	230	280	430	250	330	510	280	360	510				
		176.207.1Y.11.00 176.407.1Y.11.00 176.507.1Y.11.00	2,05	0,15	59,20	0,15	3,64	3,36	1,00	0,35	200	280	410	280	360	480	330	430	530	330	480	690	410	480	660		
				0,30	84,97	0,30	5,37	4,91		0,70	200	280	410	280	360	480	300	410	580	360	460	710	410	530	760		
				0,70	129,79	0,70	8,53	7,87		1,00	150	230	360	230	300	460	280	360	530	300	430	610	360	510	740		
				1,00	159,42	1,00	10,84	10,08		1,50	-	-	-	-	-	-	-	-	-	-	-	-	-	-	-		
				1,35	184,59	1,35	12,98	12,16	2,00	0,35	100	140	220	140	190	280	180	230	360	230	280	380	250	330	480		
				1,70	206,70	1,70	14,92	14,07		0,70	100	150	230	140	190	280	180	250	380	200	280	410	250	330	480		
				2,00	226,76	2,00	16,91	15,97		1,00	100	150	250	130	180	280	170	220	330	200	280	410	240	300	480		
2,40	245,27			2,40	18,94	17,69	1,50	-		-	-	-	-	-	150	230	330	190	250	380	230	300	430				
176.207.1Y.11.00 176.407.1Y.11.00 176.507.1Y.11.00	2,05			2,75	262,64	2,75	20,86	19,64	2,75	0,35	90	130	180	110	170	250	150	200	300	180	230	330	200	280	380		
				3,15	279,03	3,15	22,82	21,53		0,70	90	130	200	130	170	250	150	200	300	180	230	360	200	280	410		
				3,50	293,98	3,50	24,72	23,33		1,00	90	110	180	120	150	250	140	190	300	170	230	330	200	280	380		
				4,00	317,15	4,00	27,80	26,33		1,50	90	130	200	110	150	250	140	200	300	150	230	360	200	280	380		
				176.207.1Y.11.00 176.407.1Y.11.00 176.507.1Y.11.00	2,05	3,15	279,03	3,15	22,82	21,53	4,00	0,35	90	110	150	110	150	230	140	190	250	150	220	360	180	250	410
						3,50	293,98	3,50	24,72	23,33		0,70	90	110	180	100	140	220	130	190	290	150	200	330	180	250	360
						4,00	317,15	4,00	27,80	26,33		1,00	80	110	190	110	150	230	130	180	280	150	230	330	170	250	380
									1,50	-		-	-	100	150	230	130	180	250	150	200	330	170	240	360		





Bestell-Nr.	Engster Querschnitt Ø [mm]	Flüssigkeit		Luft			Strahlmessungen [mm] im Abstand von D ₁ , D ₂ und D ₃																		
		Flüssigkeitsdruck p [bar]	V̇ Wasser [l/h]	Luftdruck p Luft [bar]	Zerstäubungsluft [m³/h]	Strahlluft [m³/h]	Zerstäubungsluft [bar]	Flüssigkeitsdruck p [bar]	Strahlluft [bar]																
									0,70			1,00			1,40			1,75			2,00				
									Ø D ₁ = 150 mm	Ø D ₂ = 230 mm	Ø D ₃ = 380 mm	Ø D ₁ = 150 mm	Ø D ₂ = 230 mm	Ø D ₃ = 380 mm	Ø D ₁ = 150 mm	Ø D ₂ = 230 mm	Ø D ₃ = 380 mm	Ø D ₁ = 150 mm	Ø D ₂ = 230 mm	Ø D ₃ = 380 mm	Ø D ₁ = 150 mm	Ø D ₂ = 230 mm	Ø D ₃ = 380 mm		
176.208.1Y.11.00 176.408.1Y.11.00 176.508.1Y.11.00	2,36	0,15	97,20	0,15	3,84	4,40	1,00	0,35	190	280	430	280	360	610	300	460	710	-	-	-	-	-	-		
		0,30	114,76	0,30	4,64	5,28		0,70	190	280	430	250	360	610	330	480	760	-	-	-	-	-	-		
		0,70	162,98	0,70	6,80	7,87		1,00	-	-	-	230	330	560	300	430	690	-	-	-	-	-	-		
		1,00	199,13	1,00	8,63	10,08		1,50	-	-	-	250	360	530	300	380	580	-	-	-	-	-	-		
		1,35	229,60	1,35	10,21	12,16	2,00	0,35	110	190	300	170	250	360	200	280	410	230	330	460	280	460	560		
		1,70	256,24	1,70	11,86	14,07		0,70	110	180	250	170	230	360	220	280	410	230	360	510	270	380	530		
		2,00	280,70	2,00	13,37	15,97		1,00	110	170	230	140	200	330	190	250	410	230	300	480	280	380	610		
		2,40	302,99	2,40	14,99	17,69		1,50	-	-	-	150	200	330	200	280	380	220	300	460	270	380	560		
		176.209.1Y.11.00 176.409.1Y.11.00 176.509.1Y.11.00	2,54	0,15	82,06	0,15	1,87	3,36	1,00	0,35	200	300	460	280	380	610	330	460	710	410	530	760	460	660	810
				0,30	119,53	0,30	3,77	4,91		0,70	200	280	430	280	410	610	330	480	690	410	560	740	460	640	810
				0,69	180,05	0,69	6,58	7,87		1,00	-	-	-	-	-	-	300	460	690	410	510	690	430	580	810
				1,03	221,23	1,03	8,50	10,08		1,50	-	-	-	-	-	-	300	460	690	380	530	760	430	580	810
1,38	255,60			1,38	10,13	12,16	2,00	0,35	130	200	300	180	250	380	200	280	460	250	330	510	280	360	560		
1,72	285,50			1,72	11,57	14,07		0,70	130	180	280	170	230	360	200	280	460	230	330	560	280	380	610		
2,07	312,94			2,07	13,13	15,97		1,00	100	170	280	170	230	360	200	280	430	230	330	510	280	380	560		
2,41	338,83			2,41	14,71	17,69		1,50	-	-	-	-	-	-	200	250	430	230	300	460	250	380	560		
176.209.1Y.11.00 176.409.1Y.11.00 176.509.1Y.11.00	2,54			2,76	362,49	2,76	16,26	19,64	2,75	0,35	100	150	230	150	200	330	170	230	410	200	280	460	240	360	510
				3,10	384,75	3,10	17,75	21,53		0,70	100	150	230	140	190	300	180	240	410	200	280	460	230	360	560
				3,45	405,71	3,45	19,33	23,33		1,00	90	140	230	140	190	300	180	250	410	200	280	460	250	360	560
				4,00	436,86	4,00	21,83	26,33		1,50	100	140	200	140	190	300	180	250	410	200	280	460	230	330	510
		176.209.1Y.11.00 176.409.1Y.11.00 176.509.1Y.11.00	2,54	3,10	384,75	3,10	17,75	21,53	4,00	0,35	100	140	200	130	180	250	140	190	280	180	250	360	190	250	410
				3,45	405,71	3,45	19,33	23,33		0,70	90	130	200	130	180	280	150	200	300	170	230	360	200	280	410
				4,00	436,86	4,00	21,83	26,33		1,00	90	130	180	110	150	250	140	200	300	180	230	410	200	280	460
										1,50	-	-	-	110	150	250	140	180	300	170	230	410	190	280	460

Hinweis:

Die 4. Stelle in der Bestellnummer (2, 4 oder 5) steht für die Gehäusevariante (Details dazu s. Seite 54).



Ersatzteilset für Pneumatik-Zerstäuberdüsen Baureihe 176 ViscoMist



Übersicht Ersatzteil- und Leistungsset

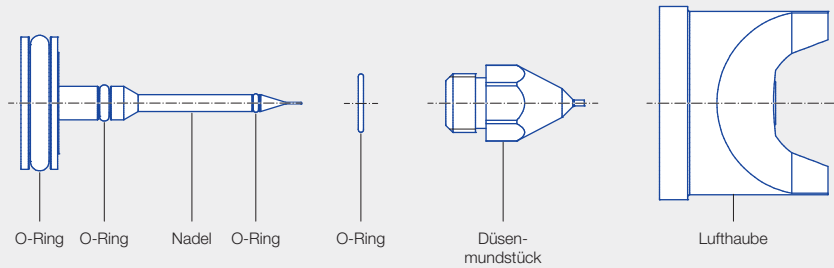

Ersatzteilset

Ersatzteilset für den Austausch der Hauptverschleißteile der Düse, bestehend aus:

- Nadel (Edelstahl 1.4404)
- O-Ringen (Viton)
- Düsenmundstück (Edelstahl 1.4404)

Bestell-Nr.	Engster Querschnitt Ø [mm]	Für Düsen
Type		
017.601.1Y.01	0,38	176.xx1.1Y.11.00
017.602.1Y.01	0,58	176.xx2.1Y.11.00
017.603.1Y.01	0,79	176.xx3.1Y.11.00
017.604.1Y.01	1,07	176.xx4.1Y.11.00
017.605.1Y.01	1,32	176.xx5.1Y.11.00
017.606.1Y.01	1,32	176.xx6.1Y.11.00
017.607.1Y.01	2,05	176.xx7.1Y.11.00
017.608.1Y.01	2,36	176.xx8.1Y.11.00
017.609.1Y.01	2,54	176.xx9.1Y.11.00

Leistungsset

Leistungsset für den Austausch der Hauptverschleißteile der Düse sowie der Lufthaube, bestehend aus:

- Nadel (Edelstahl 1.4404)
- O-Ringen (Viton)
- Düsenmundstück (Edelstahl 1.4404)
- Lufthaube (Edelstahl 1.4404)

Bestell-Nr.	Engster Querschnitt Ø [mm]	Für Düsen
Type		
017.601.1Y.00	0,38	176.xx1.1Y.11.00
017.602.1Y.00	0,58	176.xx2.1Y.11.00
017.603.1Y.00	0,79	176.xx3.1Y.11.00
017.604.1Y.00	1,07	176.xx4.1Y.11.00
017.605.1Y.00	1,32	176.xx5.1Y.11.00
017.606.1Y.00	1,32	176.xx6.1Y.11.00
017.607.1Y.00	2,05	176.xx7.1Y.11.00
017.608.1Y.00	2,36	176.xx8.1Y.11.00
017.609.1Y.00	2,54	176.xx9.1Y.11.00

Hinweis:

Eine Anleitung für den Austausch einzelner oder aller Komponenten der Düsen ist im Lieferumfang der Ersatzteilsets sowie der Leistungssets enthalten.

O-Ring-Set

Type	Bestell-Nr.		Bestehend aus 4 O-Ringen, passend für alle Düsen der Baureihe 176
	Mat.-Nr. 7A	6C	
	Viton	EPDM	
017.600.xx.01.03	●	●	

Werkstoff Viton (7A) ist der Standardwerkstoff der O-Ringe.
EPDM (6C) ist optional erhältlich.

Bestell- Type + Material-Nr. = Bestell-Nr.
beispiel: 017.600.xx.01.03 + 7A = 017.600.7A.01.03



KONTAKT: Lechler GmbH · Ulmer Straße 128 · 72555 Metzingen · Telefon +49 7123 962-0 · ind@lechler.de · www.lechler.com

